



Trauma

Product Catalogue



Trauma

Product Catalogue



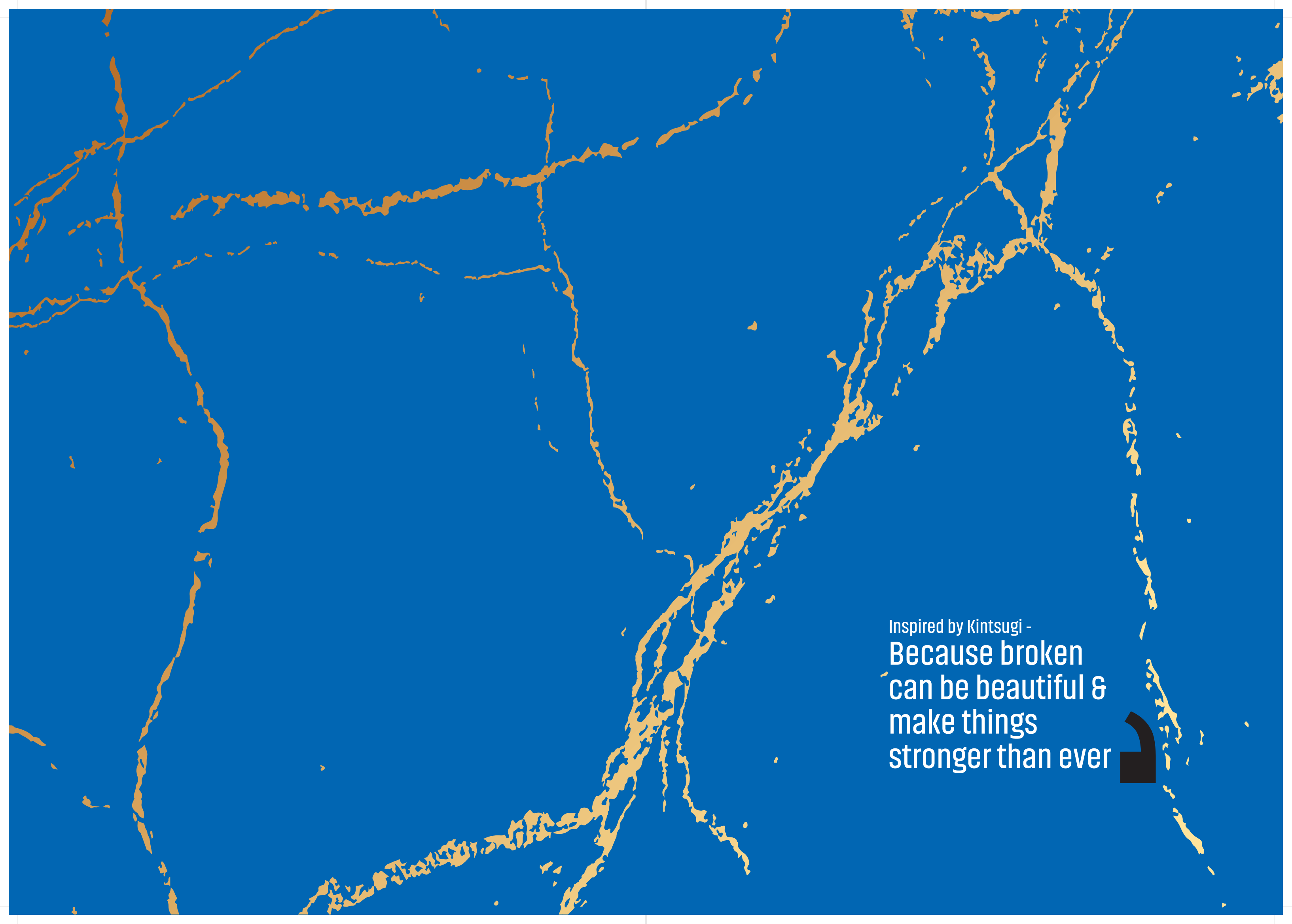

Inspired by Kintsugi -
**Because broken
can be beautiful &
make things
stronger than ever**



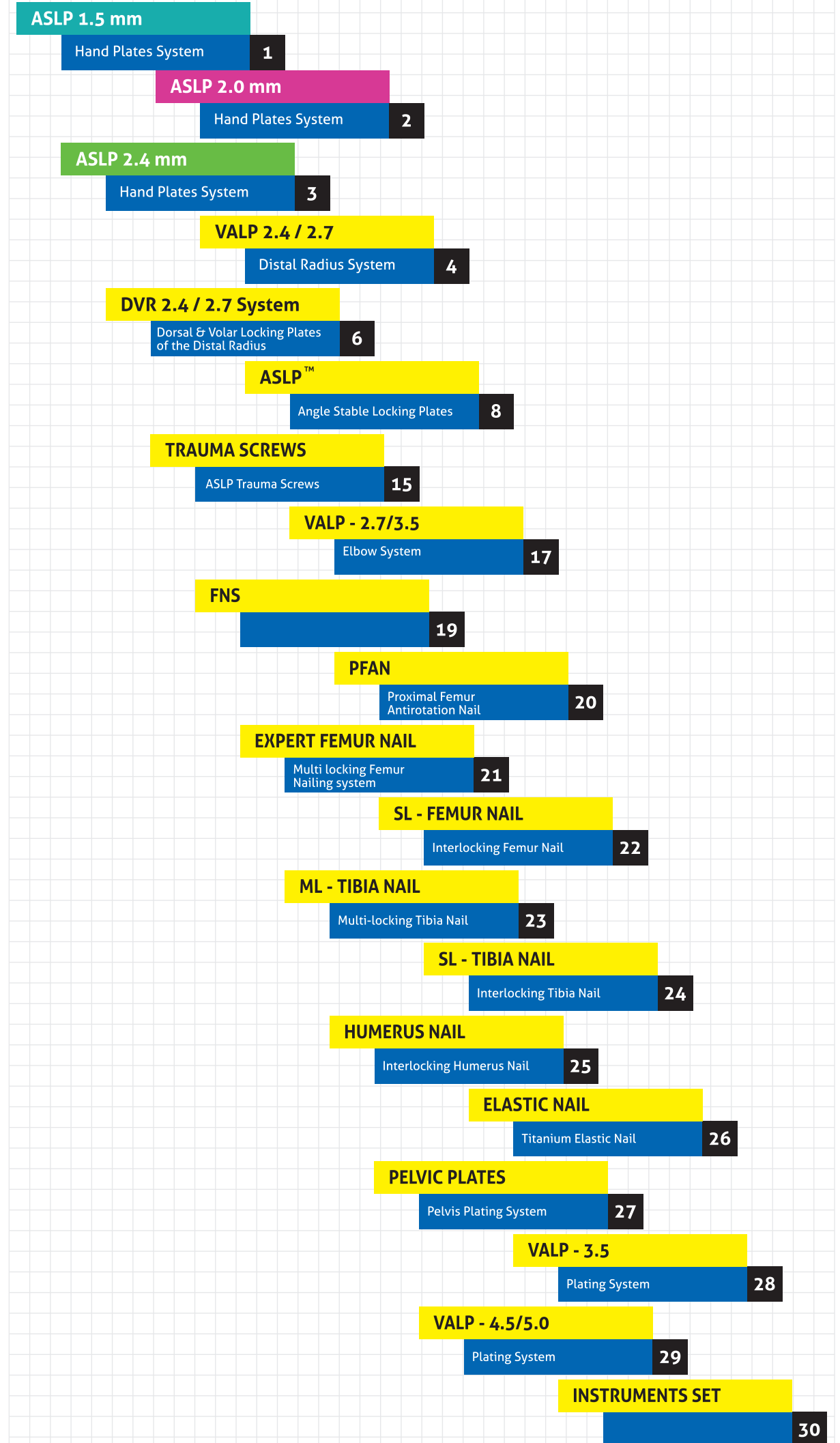

ASLP 1.5 mm

Hand Plates System

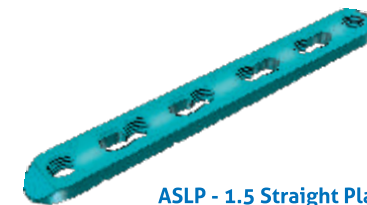
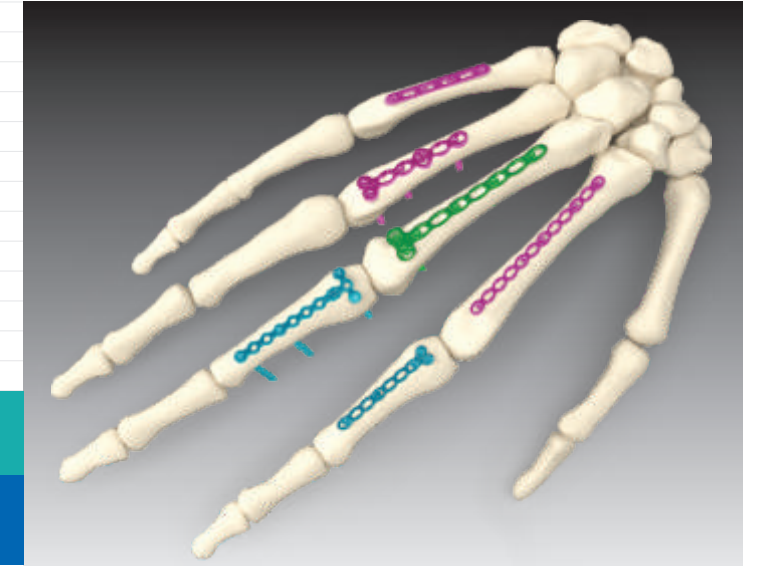

ASLP - 1.5 Straight Plate
 | PT179.04 - 4 Hole
 | PT179.06 - 6 Hole

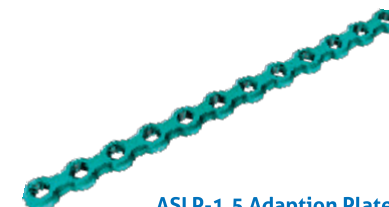

ASLP-1.5 Adaption Plate
 | PT180.06 - 6 Hole
 | PT180.12 - 12 Hole



ASLP-1.5 T-Plate
 | PT181.38 - 3+8 Hole

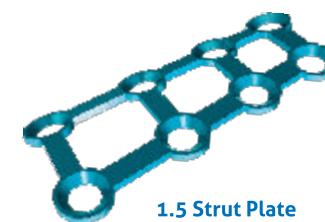

1.5 Strut Plate
 | PT182.08.01 - 8 Hole Right
 | PT182.08.02 - 8 Hole Left

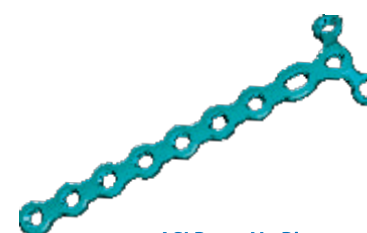

ASLP-1.5 Y-Plate
 | PT183.38 - 3+8 Hole

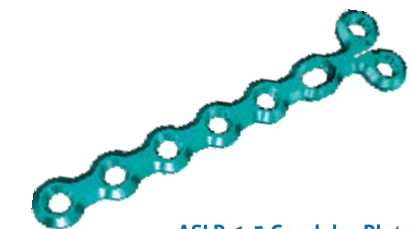

ASLP-1.5 Condylar Plate
 | PT184.26 - 2+6 Hole



1.5 Adaption Plate
 | PT185.06 - 6 Hole
 | PT185.12 - 12 Hole



1.5 mm Cortex Screw self tapping (C.H.)

ST168.06 - L 6mm	ST168.14 - L 14mm
ST168.07 - L 7mm	ST168.15 - L 15mm
ST168.08 - L 8mm	ST168.16 - L 16mm
ST168.09 - L 9mm	ST168.18 - L 18mm
ST168.10 - L 10mm	ST168.20 - L 20mm
ST168.11 - L 11mm	ST168.22 - L 22mm
ST168.12 - L 12mm	ST168.24 - L 24mm
ST168.13 - L 13mm	



1.5 mm Locking Screw self tapping (C.H.)

ST169.06 - L 6mm	ST169.14 - L 14mm
ST169.07 - L 7mm	ST169.15 - L 15mm
ST169.08 - L 8mm	ST169.16 - L 16mm
ST169.09 - L 9mm	ST169.18 - L 18mm
ST169.10 - L 10mm	ST169.20 - L 20mm
ST169.11 - L 11mm	ST169.22 - L 22mm
ST169.12 - L 12mm	ST169.24 - L 24mm
ST169.13 - L 13mm	

ASLP 2.0 mm

Hand Plates System



ASLP-2.0 Straight Plate

- | | |
|-------------------|--------------------|
| PT186.04 - 4 Hole | PT186.07 - 7 Hole |
| PT186.05 - 5 Hole | PT186.08 - 8 Hole |
| PT186.06 - 6 Hole | PT186.10 - 10 Hole |



ASLP-2.0 Distal Ulna Hook Plate

- PT343.07 - 7 Hole



2.0 Adaption Plate

- PT187.12 - 12 Hole



ASLP-2.0 T-Adaption Plate

- PT192.27 - 2+7 Hole



ASLP-2.0 Condylar Plate

- PT188.27 - 2+7 Hole



ASLP-2.0 Y-Adaption Plate

- PT193.37 - 3+7 Hole



ASLP-2.0 Rotation Correction Plate

- PT189.24 - 2+4 Hole
PT189.25 - 2+5 Hole



2.0 Mini H-Plate

- PT194.04 - 4 Hole



ASLP-2.0 T - Plate

- PT190.37 - 3+7 Hole



2.0mm Cortex Screw self tapping (C.H.)

- | | |
|-------------------|-------------------|
| ST170.06 - L 6mm | ST170.18 - L 18mm |
| ST170.07 - L 7mm | ST170.20 - L 20mm |
| ST170.08 - L 8mm | ST170.22 - L 22mm |
| ST170.09 - L 9mm | ST170.24 - L 24mm |
| ST170.10 - L 10mm | ST170.26 - L 26mm |
| ST170.11 - L 11mm | ST170.28 - L 28mm |
| ST170.12 - L 12mm | ST170.30 - L 30mm |
| ST170.13 - L 13mm | ST170.32 - L 32mm |
| ST170.14 - L 14mm | ST170.34 - L 34mm |
| ST170.16 - L 16mm | ST170.38 - L 38mm |



ASLP-2.0 Adaption Plate

- PT191.12 - 12 Hole



2.0mm Locking Screw self tapping (C.H.)

- | | |
|-------------------|-------------------|
| ST171.06 - L 6mm | ST171.16 - L 16mm |
| ST171.07 - L 7mm | ST171.18 - L 18mm |
| ST171.08 - L 8mm | ST171.20 - L 20mm |
| ST171.09 - L 9mm | ST171.22 - L 22mm |
| ST171.10 - L 10mm | ST171.24 - L 24mm |
| ST171.11 - L 11mm | ST171.26 - L 26mm |
| ST171.12 - L 12mm | ST171.28 - L 28mm |
| ST171.13 - L 13mm | ST171.30 - L 30mm |
| ST171.14 - L 14mm | |



ASLP-2.4 Straight Plate

- | | |
|-------------------|--------------------|
| PT195.04 - 4 Hole | PT195.07 - 7 Hole |
| PT195.05 - 5 Hole | PT195.08 - 8 Hole |
| PT195.06 - 6 Hole | PT195.10 - 10 Hole |



2.4 Adaption Plate

- PT196.12 - 12 Hole



ASLP-2.4 T - Plate

- PT197.37 - 3+7 Hole



ASLP-2.4 Condylar Plate

- PT198.27 - 2+7 Hole



ASLP-2.4 Adaption Plate

- PT199.12 - 12 Hole



ASLP-2.4 T-Adaption Plate

- PT200.27 - 2+7 Hole

ASLP 2.4 mm

Hand Plates System



ASLP-2.4 Y - Adaption Plate

- PT201.37 - 3+7 Hole



2.4 mm Cortex Screw Self tapping (C.H.)

- | | |
|-------------------|-------------------|
| ST172.06 - L 6mm | ST172.20 - L 20mm |
| ST172.07 - L 7mm | ST172.22 - L 22mm |
| ST172.08 - L 8mm | ST172.24 - L 24mm |
| ST172.09 - L 9mm | ST172.26 - L 26mm |
| ST172.10 - L 10mm | ST172.28 - L 28mm |
| ST172.11 - L 11mm | ST172.30 - L 30mm |
| ST172.12 - L 12mm | ST172.32 - L 32mm |
| ST172.13 - L 13mm | ST172.34 - L 34mm |
| ST172.14 - L 14mm | ST172.36 - L 36mm |
| ST172.16 - L 16mm | ST172.38 - L 38mm |
| ST172.18 - L 18mm | ST172.40 - L 40mm |



2.4 mm Locking Screw Self tapping (C.H.)

- | | |
|-------------------|-------------------|
| ST173.06 - L 6mm | ST173.16 - L 16mm |
| ST173.07 - L 7mm | ST173.18 - L 18mm |
| ST173.08 - L 8mm | ST173.20 - L 20mm |
| ST173.09 - L 9mm | ST173.22 - L 22mm |
| ST173.10 - L 10mm | ST173.24 - L 24mm |
| ST173.11 - L 11mm | ST173.26 - L 26mm |
| ST173.12 - L 12mm | ST173.28 - L 28mm |
| ST173.13 - L 13mm | ST173.30 - L 30mm |
| ST173.14 - L 14mm | |

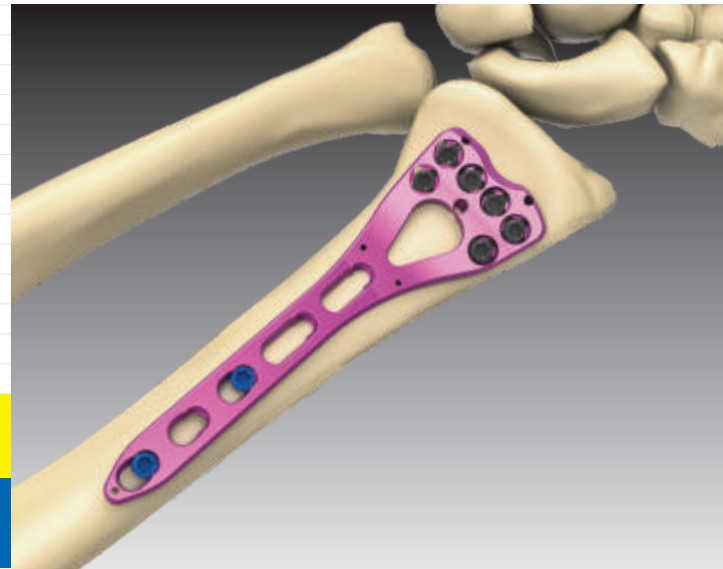

VALP 2.4 / 2.7

Distal Radius System

Two-Column Volar Plates



PT122.02.01
Right angled | Shaft Holes 2 | Head Holes 6

PT122.02.02
Left angled | Shaft Holes 2 | Head Holes 6



PT122.03.01
Right angled | Shaft Holes 3 | Head Holes 6

PT122.03.02
Left angled | Shaft Holes 3 | Head Holes 6



PT122.04.01
Right angled | Shaft Holes 4 | Head Holes 6

PT122.04.02
Left angled | Shaft Holes 4 | Head Holes 6



PT122.05.01
Right angled | Shaft Holes 5 | Head Holes 6

PT122.05.02
Left angled | Shaft Holes 5 | Head Holes 6

Two-Column Volar Wide Plates



PT230.02.01
Right angled | Shaft Holes 2 | Head Holes 7

PT230.02.02
Left angled | Shaft Holes 2 | Head Holes 7



PT230.03.01
Right angled | Shaft Holes 3 | Head Holes 7

PT230.03.02
Left angled | Shaft Holes 3 | Head Holes 7



PT230.04.01
Right angled | Shaft Holes 4 | Head Holes 7

PT230.04.02
Left angled | Shaft Holes 4 | Head Holes 7



PT230.05.01
Right angled | Shaft Holes 5 | Head Holes 7

PT230.05.02
Left angled | Shaft Holes 5 | Head Holes 7

Extra-Articular Volar Plates



PT121.43.01
Right angled | Shaft Holes 3 | Head Holes 4

PT121.43.02
Left angled | Shaft Holes 3 | Head Holes 4



PT121.45.01
Right angled | Shaft Holes 5 | Head Holes 4

PT121.45.02
Left angled | Shaft Holes 5 | Head Holes 4



PT121.53.01
Right angled | Shaft Holes 3 | Head Holes 5

PT121.53.02
Left angled | Shaft Holes 3 | Head Holes 5



PT121.55.01
Right angled | Shaft Holes 5 | Head Holes 5

PT121.55.02
Left angled | Shaft Holes 5 | Head Holes 5

Volar Rim Plates, Standard

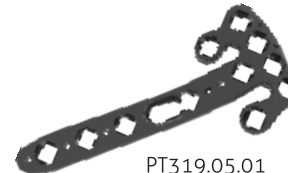

PT319.05.01
Right angled | Shaft Holes 5 | Head Holes 6

PT319.05.02
Left angled | Shaft Holes 5 | Head Holes 6

VALP - Screws



2.4 Variable Angle Locking Screw

ST126.10 - L 10mm	ST126.22 - L 22mm
ST126.12 - L 12mm	ST126.24 - L 24mm
ST126.14 - L 14mm	ST126.26 - L 26mm
ST126.16 - L 16mm	ST126.28 - L 28mm
ST126.18 - L 18mm	ST126.30 - L 30mm
ST126.20 - L 20mm	



2.4 mm Cortex Screw

ST127.12 - L 12mm	ST127.22 - L 22mm
ST127.14 - L 14mm	ST127.24 - L 24mm
ST127.16 - L 16mm	ST127.26 - L 26mm
ST127.18 - L 18mm	ST127.28 - L 28mm
ST127.20 - L 20mm	ST127.30 - L 30mm



2.7 mm Cortex Screw

ST128.12 - L 12mm	ST128.22 - L 22mm
ST128.14 - L 14mm	ST128.24 - L 24mm
ST128.16 - L 16mm	ST128.26 - L 26mm
ST128.18 - L 18mm	ST128.28 - L 28mm
ST128.20 - L 20mm	ST128.30 - L 30mm



2.4 mm Locking Screw Self Tapping

ST030.10 - L 10mm	ST030.24 - L 24mm
ST030.12 - L 12mm	ST030.26 - L 26mm
ST030.14 - L 14mm	ST030.28 - L 28mm
ST030.16 - L 16mm	ST030.30 - L 30mm
ST030.18 - L 18mm	ST030.35 - L 35mm
ST030.20 - L 20mm	ST030.40 - L 40mm
ST030.22 - L 22mm	

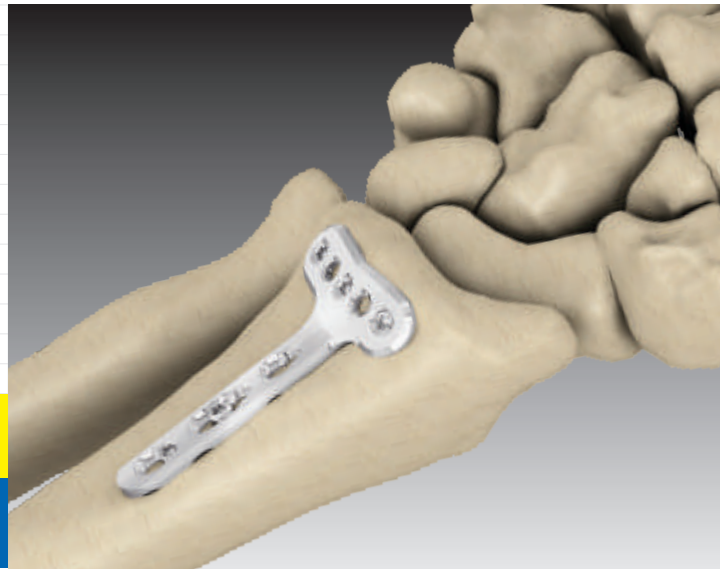
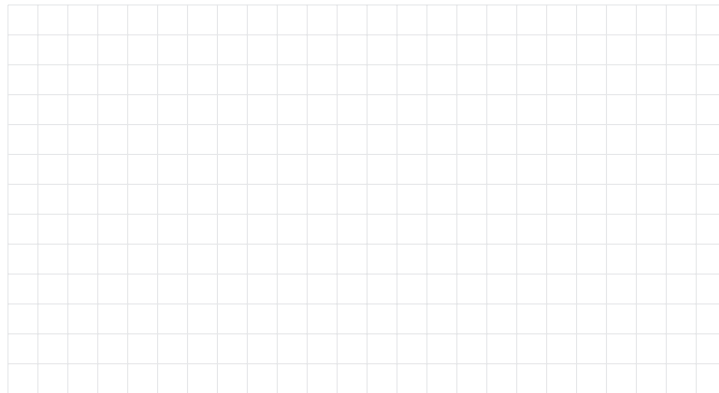

DVR 2.4 / 2.7 System

Dorsal & Volar Locking Plates of the Distal Radius

Dorsal Plates



PT075.05
Straight | Shaft Holes 5

PT075.06
Straight | Shaft Holes 6

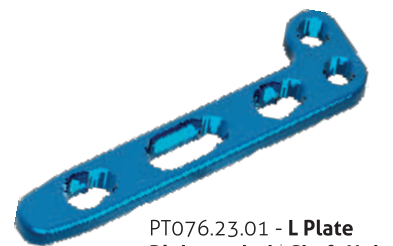

PT076.23.01 - L Plate
Right angled | Shaft Holes 3 | Head Holes 2

PT076.23.02 - L Plate
Left angled | Shaft Holes 3 | Head Holes 2

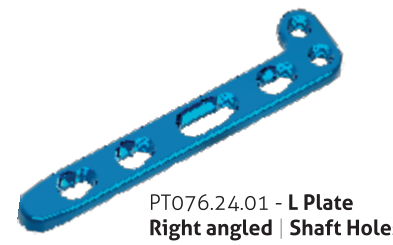

PT076.24.01 - L Plate
Right angled | Shaft Holes 4 | Head Holes 2

PT076.24.02 - L Plate
Left angled | Shaft Holes 4 | Head Holes 2

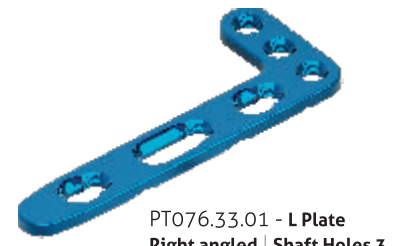

PT076.33.01 - L Plate
Right angled | Shaft Holes 3 | Head Holes 3

PT076.33.02 - L Plate
Left angled | Shaft Holes 3 | Head Holes 3

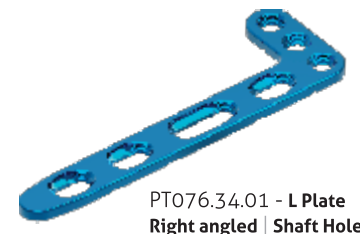

PT076.34.01 - L Plate
Right angled | Shaft Holes 4 | Head Holes 3

PT076.34.02 - L Plate
Left angled | Shaft Holes 4 | Head Holes 3

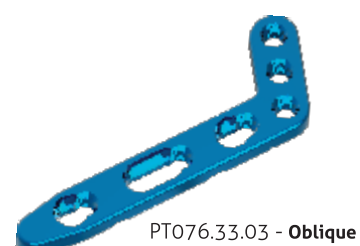

PT076.33.03 - Oblique
Right angled | Shaft Holes 3 | Head Holes 3

PT076.33.04 - Oblique
Left angled | Shaft Holes 3 | Head Holes 3

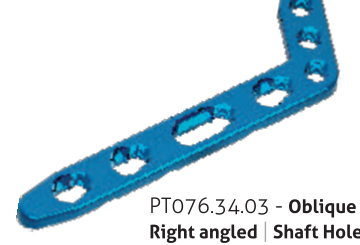

PT076.34.03 - Oblique
Right angled | Shaft Holes 4 | Head Holes 3

PT076.34.04 - Oblique
Left angled | Shaft Holes 4 | Head Holes 3



PT077.33 - T Plate
Shaft Holes 3 | Head Holes 3

PT077.34 - T Plate
Shaft Holes 4 | Head Holes 3

Volar Plates

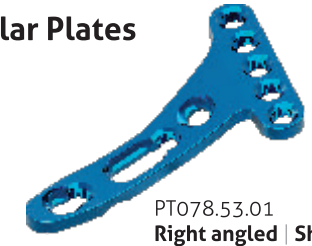

PT078.53.01
Right angled | Shaft Holes 3 | Head Holes 5

PT078.53.02
Left angled | Shaft Holes 3 | Head Holes 5



PT078.55.01
Right angled | Shaft Holes 5 | Head Holes 5

PT078.55.02
Left angled | Shaft Holes 5 | Head Holes 5



PT079.53.01 - Buttress
Right angled | Shaft Holes 3 | Head Holes 5

PT079.53.02 - Buttress
Left angled | Shaft Holes 3 | Head Holes 5



PT080.43.01 - Extra-articular
Right angled | Shaft Holes 3 | Head Holes 4

PT080.43.02 - Extra-articular
Left angled | Shaft Holes 3 | Head Holes 4



PT080.45.01 - Extra-articular
Right angled | Shaft Holes 5 | Head Holes 4

PT080.45.02 - Extra-articular
Left angled | Shaft Holes 5 | Head Holes 4



PT080.53.01 - Extra-articular
Right angled | Shaft Holes 3 | Head Holes 5

PT080.53.02 - Extra-articular
Left angled | Shaft Holes 3 | Head Holes 5



PT080.55.01 - Extra-articular
Right angled | Shaft Holes 5 | Head Holes 5

PT080.55.02 - Extra-articular
Left angled | Shaft Holes 5 | Head Holes 5

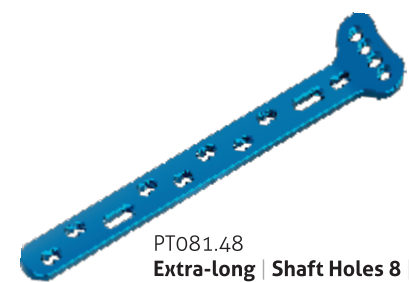

PT081.48
Extra-long | Shaft Holes 8 | Head Holes 4

PT081.410
Extra-long | Shaft Holes 10 | Head Holes 4

PT081.412
Extra-long | Shaft Holes 12 | Head Holes 4

PT081.414
Extra-long | Shaft Holes 14 | Head Holes 4

Dorsal & Volar Radius Plates Screws



2.4 mm Locking Screw Self Tapping

ST030.10 - L 10mm	ST030.24 - L 24mm
ST030.12 - L 12mm	ST030.26 - L 26mm
ST030.14 - L 14mm	ST030.28 - L 28mm
ST030.16 - L 16mm	ST030.30 - L 30mm
ST030.18 - L 18mm	ST030.35 - L 35mm
ST030.20 - L 20mm	ST030.40 - L 40mm
ST030.22 - L 22mm	



2.4 mm Cortex Screw Self Tapping

ST127.12 - L 12mm	ST127.22 - L 22mm
ST127.14 - L 14mm	ST127.24 - L 24mm
ST127.16 - L 16mm	ST127.26 - L 26mm
ST127.18 - L 18mm	ST127.28 - L 28mm
ST127.20 - L 20mm	ST127.30 - L 30mm



2.7 mm Cortex Screw Self Tapping

ST128.12 - L 12mm	ST128.22 - L 22mm
ST128.14 - L 14mm	ST128.24 - L 24mm
ST128.16 - L 16mm	ST128.26 - L 26mm
ST128.18 - L 18mm	ST128.28 - L 28mm
ST128.20 - L 20mm	ST128.30 - L 30mm

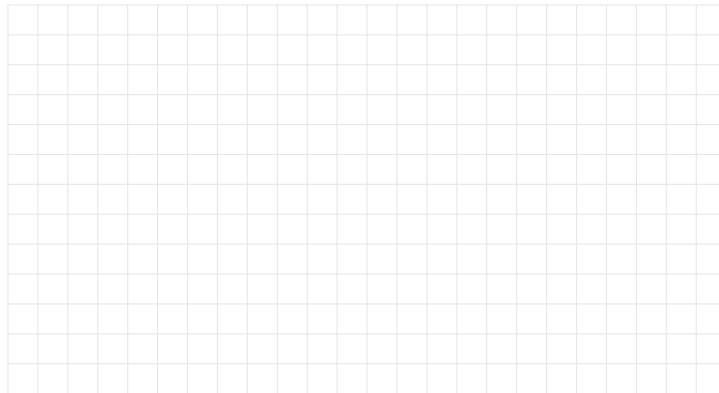

ASLP™

Angle Stable Locking Plates



ASLP-2.4 Proximal Radius Head Neck Plate
PT139.02
| 2 holes

PT139.03
| 3 holes

PT139.04
| 4 holes



ASLP-2.4 Proximal Radius Head Rim Plate
PT138.02.01 PT138.03.02
| Right, 2 Holes | Left, 3 Holes

PT138.02.02 PT138.04.01
| Left, 2 Holes | Right, 4 Holes

PT138.03.01 PT138.04.02
| Right, 3 Holes | Left, 4 Holes

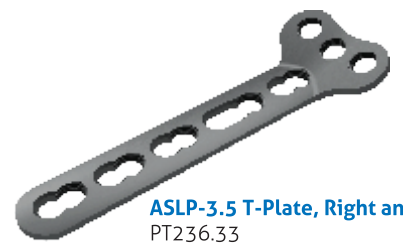

ASLP-3.5 T-Plate, Right angled
PT236.33
| Shaft 3 Holes | Head 3 Holes

PT236.35
| Shaft 5 Holes | Head 3 Holes

PT236.44
| Shaft 4 Holes | Head 4 Holes

PT236.46
| Shaft 6 Holes | Head 4 Holes

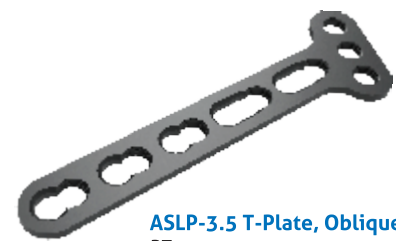

ASLP-3.5 T-Plate, Oblique-angled
PT237.33.01
Right Angled | Shaft 3 Holes | Head 3 Holes

PT237.34.01
Right Angled | Shaft 4 Holes | Head 3 Holes

PT237.35.01
Right Angled | Shaft 5 Holes | Head 3 Holes

PT237.33.02
Left Angled | Shaft 3 Holes | Head 3 Holes

PT237.34.02
Left Angled | Shaft 4 Holes | Head 3 Holes

PT237.35.02
Left Angled | Shaft 5 Holes | Head 3 Holes



ASLP-2.4 / 3.5 Distal Radius Plate Standard
PT280.03.01
| Standard 3 Hole Right

PT280.03.02
| Standard 3 Hole Left

PT280.05.01
| Standard 5 Hole Right

PT280.05.02
| Standard 5 Hole Left



ASLP-2.4/3.5 Distal Radius Plate Wide
PT281.03.01
| Wide 3 Hole Right

PT281.03.02
| Wide 3 Hole Left

PT281.05.01
| Wide 5 Hole Right

PT281.05.02
| Wide 5 Hole Left



ASLP-3.5 Superior Anterior Clavicle Plates
PT103.06.01 PT103.07.02
| Right - 6 Holes | Left - 7 Holes

PT103.06.02 PT103.08.01
| Left - 6 Holes | Right - 8 Holes

PT103.07.01 PT103.08.02
| Right - 7 Holes | Left - 8 Holes



ASLP-2.7 / 3.5mm Superior Anterior Clavicle plate with lateral extension

PT104.03.01 PT104.06.01
| Right 3 Hole | Right 6 Hole

PT104.03.02 PT104.06.02
| Left 3 Hole | Left 6 Hole

PT104.04.01 PT104.07.01
| Right 4 Hole | Right 7 Hole

PT104.04.02 PT104.07.02
| Left 4 Hole | Left 7 Hole

PT104.05.01 PT104.08.01
| Right 5 Hole | Right 8 Hole

PT104.05.02 PT104.08.02
| Left 5 Hole | Left 8 Hole



ASLP-3.5 Proximal Humerus Plates
PT070.03
| 3 Holes

PT070.05
| 5 Holes



ASLP-3.5 Long Proximal Humerus Plates
PT071.05
| 5 Holes

PT071.06
| 6 Holes

PT071.08
| 8 Holes

PT071.10
| 10 Holes

PT071.12
| 12 Holes



ASLP-3.5 Periarticular Proximal Humerus Plates
PT068.02.01 PT068.04.01
| Right 2 Holes | Right 4 Holes

PT068.02.02 PT068.04.02
| Left 2 Holes | Left 4 Holes

PT068.03.01 PT068.05.01
| Right 3 Holes | Right 5 Holes

PT068.03.02 PT068.05.02
| Left 3 Holes | Left 5 Holes



ASLP-3.5 - Clavicle Hook Plates
PT120.12.04.1 PT120.12.04.2
| 12mm, 4 Holes Right | 12mm, 4 Holes Left

PT120.12.05.1 PT120.12.05.2
| 12mm, 5 Holes Right | 12mm, 5 Holes Left

PT120.12.06.1 PT120.12.06.2
| 12mm, 6 Holes Right | 12mm, 6 Holes Left

PT120.12.07.1 PT120.12.07.2
| 12mm, 7 Holes Right | 12mm, 7 Holes Left

PT120.12.08.1 PT120.12.08.2
| 12mm, 8 Holes Right | 12mm, 8 Holes Left

Also available in PT120.15 15mm & PT120.18 18mm



ASLP-3.5 Metaphyseal Plates for Distal, Medial Humerus

PT073.07 PT073.11
| 7 Holes | 11 Holes

PT073.09 PT073.13
| 9 Holes | 13 Holes



ASLP-3.5 - Extra-articular Distal Humerus Plate

PT065.04.01 | **4 Hole Right** | PT065.08.01 | **8 Hole Right**

PT065.04.02 | **4 Hole Left** | PT065.08.02 | **8 Hole Left**

PT065.06.01 | **6 Hole Right** | PT065.10.01 | **10 Hole Right**

PT065.06.02 | **6 Hole Left** | PT065.10.02 | **10 Hole Left**



ASLP-2.7 / 3.5, Distal Humerus- Posterolateral with Lateral Support Plates

PT072.03.01 | **Right, 3 Holes** | PT072.03.02 | **Left, 3 Holes**

PT072.05.01 | **Right, 5 Holes** | PT072.05.02 | **Left, 5 Holes**

PT072.07.01 | **Right, 7 Holes** | PT072.07.02 | **Left, 7 Holes**

PT072.09.01 | **Right, 9 Holes** | PT072.09.02 | **Left, 9 Holes**



ASLP-2.7 / 3.5, Distal Humerus- Posterolateral without Support Plates

PT069.03.01 | **Right, 3 Holes** | PT069.03.02 | **Left, 3 Holes**

PT069.05.01 | **Right, 5 Holes** | PT069.05.02 | **Left, 5 Holes**

PT069.07.01 | **Right, 7 Holes** | PT069.07.02 | **Left, 7 Holes**

PT069.09.01 | **Right, 9 Holes** | PT069.09.02 | **Left, 9 Holes**



ASLP-2.7 / 3.5, Distal Humerus Medial Plates

PT066.03.01 | **Right, 3 Holes** | PT066.03.02 | **Left, 3 Holes**

PT066.05.01 | **Right, 5 Holes** | PT066.05.02 | **Left, 5 Holes**

PT066.07.01 | **Right, 7 Holes** | PT066.07.02 | **Left, 7 Holes**

PT066.09.01 | **Right, 9 Holes** | PT066.09.02 | **Left, 9 Holes**



ASLP-3.5, Olecranon Plates

PT074.02.01 | **Right, 2 Holes** | PT074.02.02 | **Left, 2 Holes**

PT074.04.01 | **Right, 4 Holes** | PT074.04.02 | **Left, 4 Holes**

PT074.06.01 | **Right, 6 Holes** | PT074.06.02 | **Left, 6 Holes**

PT074.08.01 | **Right, 8 Holes** | PT074.08.02 | **Left, 8 Holes**

PT074.10.01 | **Right, 10 Holes** | PT074.10.02 | **Left, 10 Holes**

PT074.12.01 | **Right, 12 Holes** | PT074.12.02 | **Left, 12 Holes**



3.5 One-Third Tubular Plate

PT044.04 | **4 Holes** | PT044.07 | **7 Holes** | PT044.10 | **10 Holes**

PT044.05 | **5 Holes** | PT044.08 | **8 Holes** | PT044.11 | **11 Holes**

PT044.06 | **6 Holes** | PT044.09 | **9 Holes** | PT044.12 | **12 Holes**

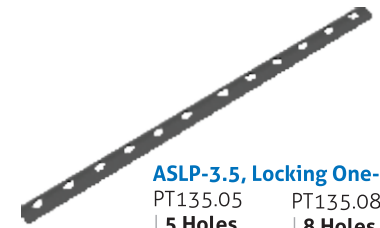

ASLP-3.5, Locking One-Third Tubular Plates

PT135.05 | **5 Holes** | PT135.08 | **8 Holes**

PT135.06 | **6 Holes** | PT135.09 | **9 Holes**

PT135.07 | **7 Holes** | PT135.10 | **10 Holes**



ASLP-3.5, Small Plates

PT041.05 | **5 Holes** | PT041.08 | **8 Holes** | PT041.11 | **11 Holes**

PT041.06 | **6 Holes** | PT041.09 | **9 Holes** | PT041.12 | **12 Holes**

PT041.07 | **7 Holes** | PT041.10 | **10 Holes** | PT041.14 | **14 Holes**



ASLP-3.5, Round Hole Reconstruction Plate

PT045.06 | **6 Holes** | PT045.10 | **10 Holes**

PT045.07 | **7 Holes** | PT045.12 | **12 Holes**

PT045.08 | **8 Holes** | PT045.14 | **14 Holes**

PT045.09 | **9 Holes**



ASLP-3.5, Reconstruction Plates

PT046.06 | **6 Holes** | PT046.09 | **9 Holes**

PT046.07 | **7 Holes** | PT046.10 | **10 Holes**

PT046.08 | **8 Holes** | PT046.12 | **12 Holes**



ASLP-4.5 / 5.0, Narrow Plates

PT043.06 | **6 Holes** | PT043.10 | **10 Holes**

PT043.07 | **7 Holes** | PT043.11 | **11 Holes**

PT043.08 | **8 Holes** | PT043.12 | **12 Holes**

PT043.09 | **9 Holes** | PT043.14 | **14 Holes**



ASLP-3.5 / 4.5 / 5.0 Metaphyseal Plates

PT048.55 | **5+5 Holes** | PT048.58 | **5+8 Holes**

PT048.56 | **5+6 Holes** | PT048.59 | **5+9 Holes**

PT048.57 | **5+7 Holes** | PT048.511 | **5+11 Holes**



ASLP-4.5 / 5.0, Broad Plates

PT042.08 | **8 Holes** | PT042.14 | **14 Holes**

PT042.10 | **10 Holes** | PT042.16 | **16 Holes**

PT042.12 | **12 Holes**



ASLP-4.5/5.0 Curved Broad Plate

PT178.16 | **16 Holes** | PT178.20 | **20 Holes**

PT178.18 | **18 Holes** | PT178.22 | **22 Holes**



ASLP-4.5 / 5.0 / 6.5 Proximal Femur Plate

PT224.06.01 | **6 Holes Right** | PT224.06.02 | **6 Holes Left**

PT224.08.01 | **8 Holes Right** | PT224.08.02 | **8 Holes Left**

PT224.10.01 | **10 Holes Right** | PT224.10.02 | **10 Holes Left**

PT224.12.01 | **12 Holes Right** | PT224.12.02 | **12 Holes Left**

PT224.14.01 | **14 Holes Right** | PT224.14.02 | **14 Holes Left**



ASLP - DHS 135° (with Long barrel 38mm)

PT067.02.38 | **2 Holes** | PT067.05.38 | **5 Holes** | PT067.10.38 | **10 Holes**

PT067.03.38 | **3 Holes** | PT067.06.38 | **6 Holes** | PT067.12.38 | **12 Holes**

PT067.04.38 | **4 Holes** | PT067.08.38 | **8 Holes**

ASLP - DHS 135° (with Short barrel 25mm)

PT067.05.25 | **5 Holes** | PT067.06.25 | **6 Holes**



ASLP-4.5 / 5.0, Distal Femoral Plates

PT092.05.01 5 Holes, Right	PT092.09.02 9 Holes, Left
PT092.05.02 5 Holes, Left	PT092.11.01 11 Holes, Right
PT092.07.01 7 Holes, Right	PT092.11.02 11 Holes, Left
PT092.07.02 7 Holes, Left	PT092.13.01 13 Holes, Right
PT092.09.01 9 Holes, Right	PT092.13.02 13 Holes, Left



ASLP-3.5, Posteromedial Proximal Tibia Plates

PT091.01 1 Hole	PT091.06 6 Holes
PT091.02 2 Holes	PT091.08 8 Hole
PT091.04 4 Hole	PT091.10 10 Holes



ASLP-3.5, Proximal Medial Tibia plates

PT097.04.01 Right, 4 Holes	PT097.04.02 Left, 4 Holes
PT097.06.01 Right, 6 Holes	PT097.06.02 Left, 6 Holes
PT097.08.01 Right, 8 Holes	PT097.08.02 Left, 8 Holes
PT097.10.01 Right, 10 Holes	PT097.10.02 Left, 10 Holes
PT097.12.01 Right, 12 Holes	PT097.12.02 Left, 12 Holes
PT097.14.01 Right, 14 Holes	PT097.14.02 Left, 14 Holes



ASLP - 3.5 Proximal Tibia Plate

PT094.06.01 Right 6 Hole	PT094.06.02 Left 6 Hole
PT094.08.01 Right 8 Hole	PT094.08.02 Left 8 Hole
PT094.10.01 Right 10 Hole	PT094.10.02 Left 10 Hole
PT094.12.01 Right 12 Hole	PT094.12.02 Left 12 Hole
PT094.14.01 Right 14 Hole	PT094.14.02 Left 14 Hole
PT094.16.01 Right 16 Hole	PT094.16.02 Left 16 Hole



ASLP-3.5, Distal Medial Tibia Plate

PT095.06.01 Right, 6 Holes	PT095.06.02 Left, 6 Holes
PT095.08.01 Right, 8 Holes	PT095.08.02 Left, 8 Holes
PT095.10.01 Right, 10 Holes	PT095.10.02 Left, 10 Holes
PT095.12.01 Right, 12 Holes	PT095.12.02 Left, 12 Holes
PT095.14.01 Right, 14 Holes	PT095.14.02 Left, 14 Holes
PT095.16.01 Right, 16 Holes	PT095.16.02 Left, 16 Holes



ASLP-3.5, Distal Anterolateral Tibia Plates

PT093.05.01 Right, 5 Holes	PT093.05.02 Left, 5 Holes
PT093.07.01 Right, 7 Holes	PT093.07.02 Left, 7 Holes
PT093.09.01 Right, 9 Holes	PT093.09.02 Left, 9 Holes
PT093.11.01 Right, 11 Holes	PT093.11.02 Left, 11 Holes
PT093.13.01 Right, 13 Holes	PT093.13.02 Left, 13 Holes



ASLP-4.5 / 5.0, Proximal Lateral Tibia

PT096.03.01 Right, 3 Holes	PT096.03.02 Left, 3 Holes
PT096.04.01 Right, 4 Holes	PT096.04.02 Left, 4 Holes
PT096.05.01 Right, 5 Holes	PT096.05.02 Left, 5 Holes
PT096.07.01 Right, 7 Holes	PT096.07.02 Left, 7 Holes
PT096.09.01 Right, 9 Holes	PT096.09.02 Left, 9 Holes
PT096.11.01 Right, 11 Holes	PT096.11.02 Left, 11 Holes
PT096.13.01 Right, 13 Holes	PT096.13.02 Left, 13 Holes



ASLP-4.5 / 5.0, T-Plates

PT052.04 4 Holes	PT052.06 6 Holes	PT052.08 8 Holes
PT052.05 5 Holes	PT052.07 7 Holes	



ASLP-4.5 / 5.0, L-Buttress Plates

PT053.04.01 Right, 4 Holes	PT053.04.02 Left, 4 Holes
PT053.05.01 Right, 5 Holes	PT053.05.02 Left, 5 Holes
PT053.06.01 Right, 6 Holes	PT053.06.02 Left, 6 Holes

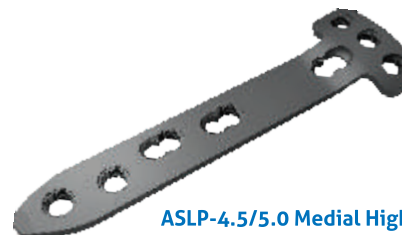

ASLP-4.5/5.0 Medial High Tibia Osteotomy Plate

PT147.04 04 Holes
PT174.04 Small 04 Holes



ASLP-4.5/5.0 Lateral High Tibia Osteotomy Plate

PT148.03.01 Right 03 Holes	PT148.03.02 Left 03 Holes
--	---------------------------------------



ASLP-4.5 / 5.0 Lateral Distal Femur Osteotomy Plate

PT175.04.01 Right, 04 Holes	PT175.04.02 Left, 04 Holes
---	--



ASLP-4.5/5.0 Medial Distal Femur 20° Osteotomy Plate

PT176.20.04.01 Right, 04 holes	PT176.20.04.02 Left, 04 holes
--	---



ASLP-4.5/5.0 Medial Distal Femur 29° Osteotomy Plate

PT176.29.04.01 Right, 04 Holes	PT176.29.04.02 Left, 04 Holes
--	---



ASLP-3.5 Calcaneal Locking Plate

PT137.60.01 Right, L-60 mm	PT137.68.01 Right, L-68 mm
PT137.60.02 Left, L-60 mm	PT137.68.02 Left, L-68 mm



ASLP-3.5 MIS anterior calcaneal small plate

PT315.05.01 Right, 5 Holes	PT315.05.02 Left, 5 Holes
--	---------------------------------------



ASLP-3.5 MIS Anterior Calcaneal Large Plate
 PT316.05.01 | Right, 5 Holes
 PT316.05.02 | Left, 5 Holes



ASLP-3.5 MIS Anterior Calcaneal Plate Small with Extension
 PT317.08.01 | Right, 2 Holes
 PT317.08.02 | Left, 2 Holes



ASLP-3.5 MIS Anterior Calcaneal Plate Large with Extension
 PT318.09.01 | Right, 3 Holes
 PT318.09.02 | Left, 3 Holes



ASLP-3.5 MIS posterior tuberosity calcaneal plate
 PT321.05.01 | Right, 5 Holes
 PT321.05.02 | Left, 5 Holes
 PT321.06.01 | Right, 6 Holes
 PT321.06.01 | Left, 6 Holes



ASLP-2.7/3.5 Distal Fibula Plate
 PT153.04.01 | Right, 4 holes
 PT153.08.01 | Right, 8 holes
 PT153.04.02 | Left, 4 holes
 PT153.08.02 | Left, 8 holes
 PT153.06.01 | Right, 6 holes
 PT153.10.01 | Right, 10 holes
 PT153.06.02 | Left, 6 holes
 PT153.10.02 | Left, 10 holes



Pedi Plate
 PT288.12 | L-12 mm
 PT288.16 | L-16 mm

TRAUMA SCREWS

ASLP Trauma Screws

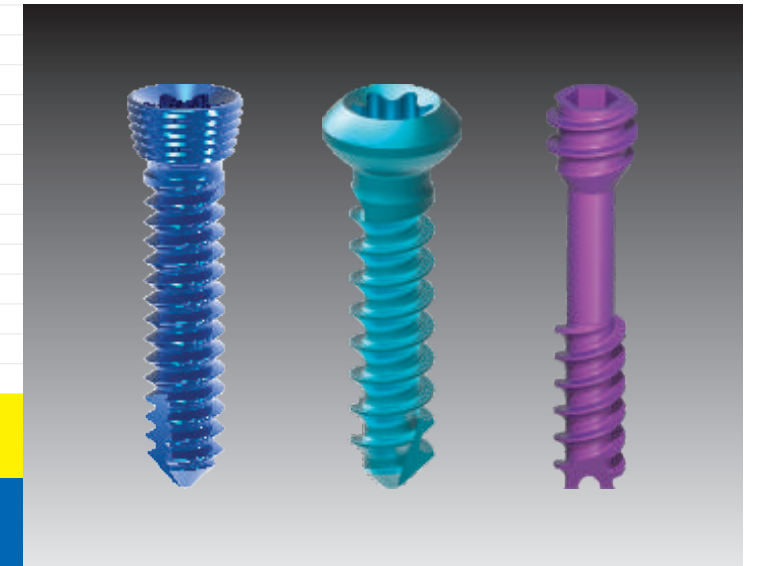

2.4 mm Locking Screw Self tapping
 | Length 10 mm to 30 mm (2 mm increment)
 Also available in ST030.10 to ST030.30

| Length 35 mm & 40 mm
 Also available in ST030.35 & ST030.40



2.4 mm Cortex Screw Self tapping
 | Length 12 mm to 30 mm (2 mm increment)
 Also available in ST127.12 to ST127.30



2.7 mm Locking Screw Self tapping
 | Length 12 mm to 40 mm (2 mm increment)
 Also available in ST031.12 to ST031.40

| Length 45 mm & 50 mm
 Also available in ST031.45 & ST031.50



2.7 mm Cortex Screw Self tapping
 | Length 12 mm to 30 mm (2 mm increment)
 Also available in ST128.12 to ST128.30



3.5 mm Locking Screw, Self - Tapping
 | Length 8 to 50 mm (2 mm increment)
 Also available in ST032.8 to ST032.50

| Length 35 to 100 mm (5 mm increment)
 Also available in ST032.35 to ST032.100



3.5 mm Cortex Screw, Self - Tapping
 | Length 12 to 60 mm (2 mm increment)
 Also available in ST028.12 to ST028.60

| Length 45
 Also available in ST028.45



5 mm Locking Screw, Self - Tapping
 | Length 18 to 50 mm (2 mm increment)
 Also available in ST033.18 to ST033.50

| Length 55 to 95 mm (5 mm increment)
 Also available in ST033.55 to ST033.95



4.5 mm Cortex Screw, Self - Tapping
 | Length 18 to 70 mm (2 mm increment)
 Also available in ST029.18 to ST029.70

| Length 55 & 65 mm (5 mm increment)
 Also available in ST029.55 & ST029.65



5.0 mm Periprosthetic Locking Screw
 | Length 8 to 18 mm (2 mm increment)
 Also available in ST223.08 to ST223.18



5.0 mm Spacer Screws
 | Length 2
 Also available in ST233.02



ASLP-4.5 / 5.0 Wire Mount
 ST294



4.0 mm Cancellous Screw, (Fully Threaded)
 | Length 12 to 30 mm (2 mm increment)
 Also available in ST036.12 to ST036.30

| Length 35 to 60 mm (5 mm increment)
 Also available in ST036.35 to ST036.60



4.0 mm Cancellous Screws (Partially Threaded)
 | Length 12 to 30 mm (2 mm increment)
 Also available in ST037.12 to ST037.30

| Length 35 to 60 mm (5 mm increment)
 Also available in ST037.35 to ST037.60



6.5 mm Cancellous Screw (Fully Threaded)
| Length 35 to 105 mm (5 mm increment)
Also available in *ST034.35 to ST034.105*



6.5 mm Cancellous Screw, 16 mm Partially Threaded
| Length 35 to 110 mm (5 mm increment)
Also available in *ST229.35 to ST229.110*



6.5 mm Cancellous Screw, 32 mm Partially Threaded
| Length 45 to 110 mm (5 mm increment)
Also available in *ST035.45 to ST035.110*



4.5 mm Cannulated Cancellous Screw, Partially Threaded
| Length 20 to 80 mm (2 mm increment)
Also available in *ST039.20 to ST039.80*



6.5 mm Cannulated Cancellous Screw, 32mm Partially Threaded
| Length 45 to 120 mm (5 mm increment)
Also available in *ST107.30 to ST107.120*



6.5 mm Cannulated Cancellous Screws, 16 mm Partially Threaded (Titanium)
| Length 30 to 120 mm (5 mm increment)
Also available in *ST040.30 to ST040.120*



2.4 mm Headless Compression Screws, Short Thread
| Length 10 to 40 mm (2 mm increment)
Also available in *ST273.10 to ST273.40*



2.4 mm Headless Compression Screws, Long Thread
| Length 18 to 40 mm (2 mm increment)
Also available in *ST274.18 to ST274.40*



3.0 mm Headless Compression Screw
| Length 12 to 40 mm (2 mm increment)
Also available in *ST105.12 to ST105.40*



Ø 4.5mm Headless Compression Screws, short thread
| Length 20 to 60 mm (2 mm increment)
Also available in *ST313.20 to ST313.60*



DHS Screw
| Length 65 to 110 mm (5 mm increment)
Also available in *ST313.65 to ST313.110*



DHS Screw
| Length 60 to 115 mm (5 mm increment)
Also available in *ST038.60 to ST038.115*



Ø4.0 mm Cannulated Screws
Length 16 to 36 mm (2 mm increment)
Also available in *ST287.16 to ST287.36*



VALP - 2.7/3.5

Elbow System



VALP - 2.7/3.5, Olecranon Plate
PT207.02.01 | Right 2 hole
PT207.02.02 | Left 2 hole

PT207.04.01 | Right 4 hole
PT207.04.02 | Left 4 hole

PT207.06.01 | Right 6 hole
PT207.06.02 | Left 6 hole



VALP - 2.7/3.5, Medial Distal Humerus Plate
PT204.01.01 | Right 1 hole
PT204.01.02 | Left 1 hole

PT204.02.01 | Right 2 hole
PT204.02.02 | Left 2 hole

PT204.04.01 | Right 4 hole
PT204.04.02 | Left 4 hole



VALP - 2.7/3.5, Proximal Olecranon Plate
PT208.02.01 | Right 2 hole
PT208.02.02 | Left 2 hole



VALP - 2.7/3.5, Extended Medial Distal Humerus Plate
PT205.01.01 | Right 1 hole
PT205.01.02 | Left 1 hole

PT205.02.01 | Right 2 hole
PT205.02.02 | Left 2 hole

PT205.04.01 | Right 4 hole
PT205.04.02 | Left 4 hole



VALP - 2.7/3.5, Distal humerus - Posterolateral with Lateral Support Plate
PT202.03.01 | Right 3 hole
PT202.03.02 | Left 3 hole

PT202.04.01 | Right 4 hole
PT202.04.02 | Left 4 hole

PT202.07.01 | Right 7 hole
PT202.07.02 | Left 7 hole



VALP - 2.7/3.5, Lateral Distal Humerus Plate
PT206.01.01 | Right 1 hole
PT206.01.02 | Left 1 hole

PT206.02.01 | Right 2 hole
PT206.02.02 | Left 2 hole

PT206.05.01 | Right 5 hole
PT206.05.02 | Left 5 hole



VALP - 2.7/3.5, Distal Humerus - Posterolateral without Support Plate
PT203.03.01 | Right 3 hole
PT203.03.02 | Left 3 hole

PT203.04.01 | Right 4 hole
PT203.04.02 | Left 4 hole

PT203.07.01 | Right 7 hole
PT203.07.02 | Left 7 hole



Variable Angle Locking Screw, ø 2.7mm Self - Tapping

| Length 10 to 40 mm (2 mm increment)
Also available in *ST210.10 to ST210.40*

| Length 45 & 50 mm (5 mm increment)
Also available in *ST210.45, ST210.50*



ø 3.5 mm Locking Screw, Self - Tapping

| Length 8 to 50 mm (2 mm increment)
Also available in *ST032.8 to ST032.50*

| Length 35 & 100 mm (5 mm increment)
Also available in *ST032.35 to ST032.100*



ø 3.5 mm Cortex Screw, Self - Tapping

| Length 12 to 60 mm (2 mm increment)
Also available in *ST028.12 to ST028.60*



FNS



FNS Plate
PT291.01
| 1 Holes

PT291.02
| 2 Holes



FNS Bolt

- | ST292.75, Length 75mm
- | ST292.80, Length 80mm
- | ST292.85, Length 85mm
- | ST292.90, Length 90mm
- | ST292.95, Length 95mm
- | ST292.100, Length 100mm
- | ST292.105, Length 105mm
- | ST292.110, Length 110mm
- | ST292.115, Length 115mm
- | ST292.120, Length 120mm
- | ST292.125, Length 125mm
- | ST292.130, Length 130mm



FNS Antirotation Screw

- | ST293.75, Length 75mm
- | ST293.80, Length 80mm
- | ST293.85, Length 85mm
- | ST293.90, Length 90mm
- | ST293.95, Length 95mm
- | ST293.100, Length 100mm
- | ST293.105, Length 105mm
- | ST293.110, Length 110mm
- | ST293.115, Length 115mm
- | ST293.120, Length 120mm
- | ST293.125, Length 125mm
- | ST293.130, Length 130mm

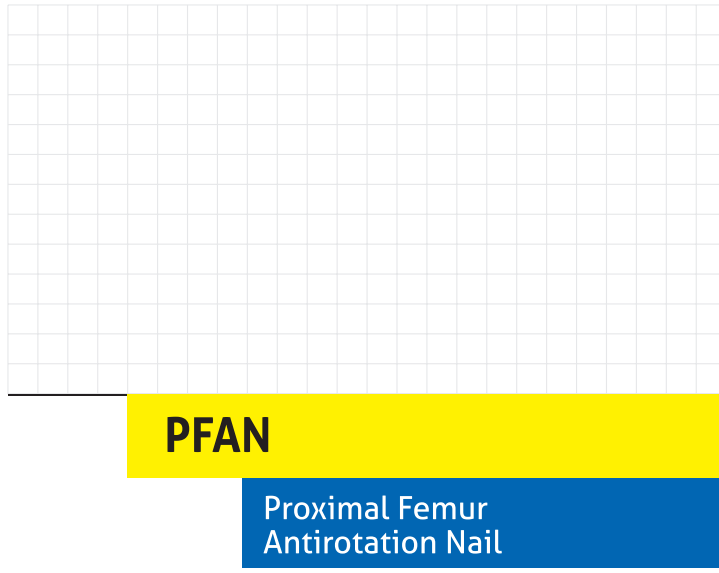

PFAN
Proximal Femur
Antirotation Nail

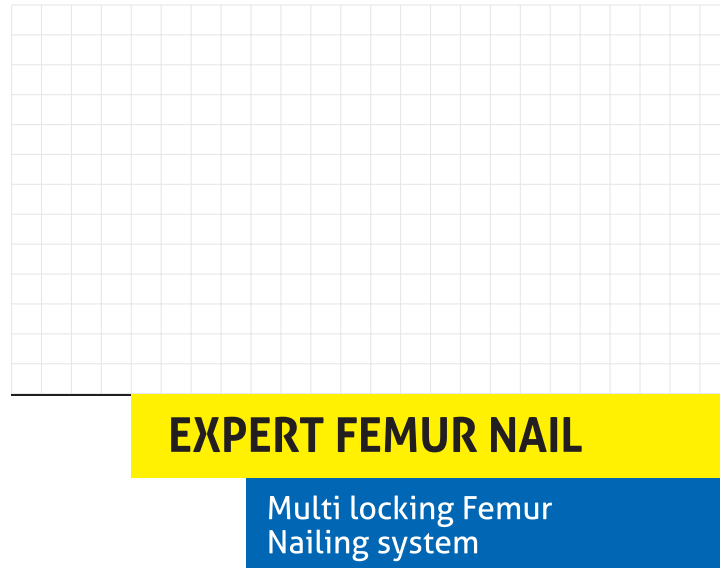

EXPERT FEMUR NAIL
Multi locking Femur
Nailing system



Blade Nail
| Dia (mm) 10.5
| Length 75 to 120 mm (5 mm increment)
Also available in *BNT101.75 to BNT101.120*



PFAN Lag Screw
| Length 70 to 110 (5 mm increment)
Also available in *ST290.70 to ST290.110*



5.00 mm Locking Bolt
| Length 26 to 60 mm (2 mm increment)
Also available in *ST100.1.26 to ST100.1.60*



End Cap
| Length 0 to 15 mm (5 mm increment)
Also available in *ECT100.2.00 to ECT100.2.15*



Short PFAN

NT100.09.180	NT100.11.180
NT100.09.220	NT100.11.220
NT100.09.240	NT100.11.240
Dia 9 mm	Dia 11 mm

NT100.10.180	NT100.12.180
NT100.10.220	NT100.12.220
NT100.10.240	NT100.12.240
Dia 10 mm	Dia 12 mm

Available in *Length (mm) 180, 220, 240*



End Cap II
| Length 0 to 15 mm (5 mm increment)
Also available in *ECT162.02.00 to ECT162.02.15*



Long PFAN

NT102.09.320.01	NT102.09.320.02
NT102.09.340.01	NT102.09.340.02
NT102.09.360.01	NT102.09.360.02
NT102.09.380.01	NT102.09.380.02
NT102.09.400.01	NT102.09.400.02
NT102.09.420.01	NT102.09.420.02
Dia 9 mm Right	Dia 9 mm Left

NT102.10.320.01	NT102.10.320.02
NT102.10.340.01	NT102.10.340.02
NT102.10.360.01	NT102.10.360.02
NT102.10.380.01	NT102.10.380.02
NT102.10.400.01	NT102.10.400.02
NT102.10.420.01	NT102.10.420.02
Dia 10 mm Right	Dia 10 mm Left

NT102.11.320.01	NT102.11.320.02
NT102.11.340.01	NT102.11.340.02
NT102.11.360.01	NT102.11.360.02
NT102.11.380.01	NT102.11.380.02
NT102.11.400.01	NT102.11.400.02
NT102.11.420.01	NT102.11.420.02
Dia 11 mm Right	Dia 11 mm Left

NT102.12.320.01	NT102.12.320.02
NT102.12.340.01	NT102.12.340.02
NT102.12.360.01	NT102.12.360.02
NT102.12.380.01	NT102.12.380.02
NT102.12.400.01	NT102.12.400.02
NT102.12.420.01	NT102.12.420.02
Dia 12 mm Right	Dia 12 mm Left

Available in *Length (mm) 320, 340, 360, 380, 400, 420*



Trochanteric Stabilisation Plate for Nails (TSPN)
PT333.06
| 6 Holes



5.00 mm Intramedullary Nail Screw
| Length 26 to 70 mm (2 mm increment)
Also available in *ST117.26 to ST117.70*



Expert Femur Nail

NT165.09.320.01	NT165.09.320.02
NT165.09.340.01	NT165.09.340.02
NT165.09.360.01	NT165.09.360.02
NT165.09.380.01	NT165.09.380.02
NT165.09.400.01	NT165.09.400.02
NT165.09.420.01	NT165.09.420.02
NT165.09.440.01	NT165.09.440.02
Dia 9 mm Right	Dia 9 mm Left

NT165.10.320.01	NT165.10.320.02
NT165.10.340.01	NT165.10.340.02
NT165.10.360.01	NT165.10.360.02
NT165.10.380.01	NT165.10.380.02
NT165.10.400.01	NT165.10.400.02
NT165.10.420.01	NT165.10.420.02
NT165.10.440.01	NT165.10.440.02
Dia 10 mm Right	Dia 10 mm Left

NT165.11.320.01	NT165.11.320.02
NT165.11.340.01	NT165.11.340.02
NT165.11.360.01	NT165.11.360.02
NT165.11.380.01	NT165.11.380.02
NT165.11.400.01	NT165.11.400.02
NT165.11.420.01	NT165.11.420.02
NT165.11.440.01	NT165.11.440.02
Dia 11 mm Right	Dia 11 mm Left

NT165.12.320.01	NT165.12.320.02
NT165.12.340.01	NT165.12.340.02
NT165.12.360.01	NT165.12.360.02
NT165.12.380.01	NT165.12.380.02
NT165.12.400.01	NT165.12.400.02
NT165.12.420.01	NT165.12.420.02
NT165.12.440.01	NT165.12.440.02
Dia 12 mm Right	Dia 12 mm Left

Available in *Length (mm) 320, 340, 360, 380, 400, 420, 440*



6.5 mm Expert Femur Nail Cannulated Anti-Rotation Screw
| Length 60 to 115 mm (5 mm increment)
Also available in *ST272.60 to ST272.115*



End Cap
| Length 0 to 15 mm (5 mm increment)
Also available in *ECT221.00 to ECT221.20*

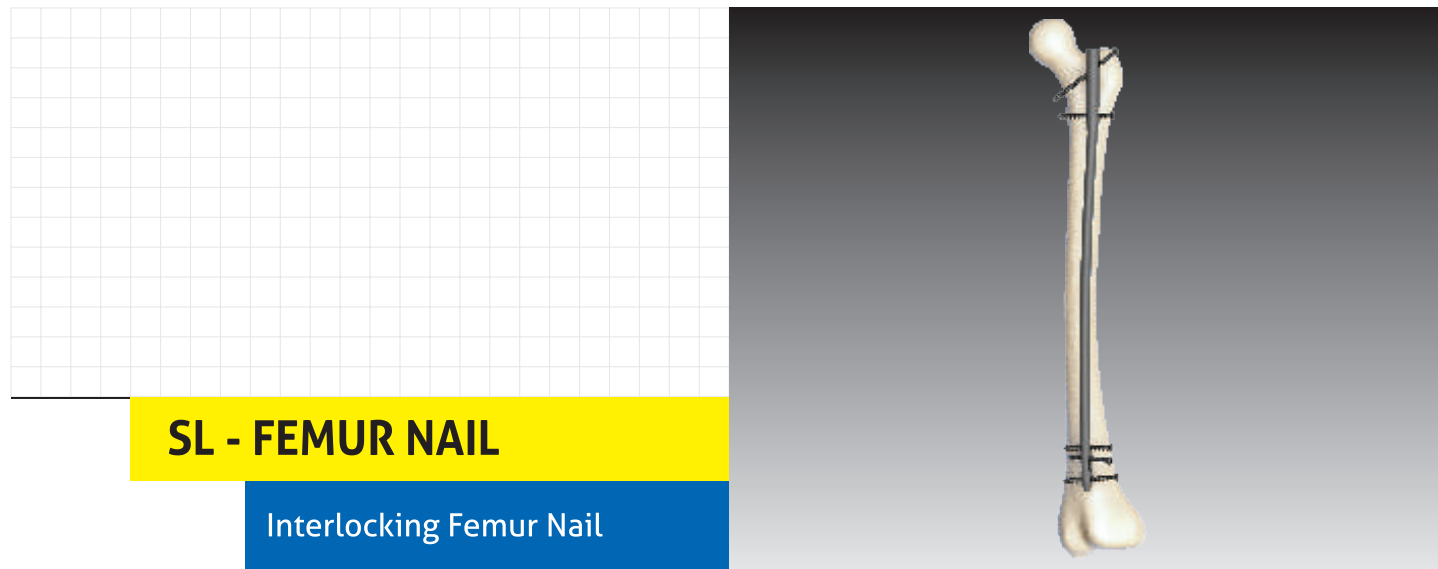

SL - FEMUR NAIL

Interlocking Femur Nail



ML - TIBIA NAIL

Multi-Locking Tibia Nail



5.00 mm Intramedullary Nail Screw
| Length 26 to 70 mm (2 mm increment)
Also available in *ST117.26 to ST117.70*

| Length (mm) 75 to 100 (5mm increment)
Also available in *ST117.75 to ST117.100*



End Cap
| Length 0 to 15 mm (5 mm increment)
Also available in *ECT124.4.00 to ECT124.4.15*



End Cap
| Length 0 to 15 mm (5 mm increment)
Also available in *ECT111.3.00 to ECT111.3.15*



4.00 mm Locking Bolt
| Length 18 to 80 (2 mm Increments)
Also available in *ST108.2.18 to ST108.2.80*



5.00 mm Locking Bolt
| Length 30 to 80 (5 mm Increments)
Also available in *ST108.3.30 to ST108.3.80*



SL - Femur Nail

NT114.09.320.01	NT114.09.320.02	NT114.11.320.01	NT114.11.320.02
NT114.09.340.01	NT114.09.340.02	NT114.11.340.01	NT114.11.340.02
NT114.09.360.01	NT114.09.360.02	NT114.11.360.01	NT114.11.360.02
NT114.09.380.01	NT114.09.380.02	NT114.11.380.01	NT114.11.380.02
NT114.09.400.01	NT114.09.400.02	NT114.11.400.01	NT114.11.400.02
NT114.09.420.01	NT114.09.420.02	NT114.11.420.01	NT114.11.420.02
NT114.09.440.01	NT114.09.440.02	NT114.11.440.01	NT114.11.440.02
Dia 9 mm Right	Dia 9 mm Left	Dia 11 mm Right	Dia 11 mm Left
NT114.10.320.01	NT114.10.320.02	NT114.12.320.01	NT114.12.320.02
NT114.10.340.01	NT114.10.340.02	NT114.12.340.01	NT114.12.340.02
NT114.10.360.01	NT114.10.360.02	NT114.12.360.01	NT114.12.360.02
NT114.10.380.01	NT114.10.380.02	NT114.12.380.01	NT114.12.380.02
NT114.10.400.01	NT114.10.400.02	NT114.12.400.01	NT114.12.400.02
NT114.10.420.01	NT114.10.420.02	NT114.12.420.01	NT114.12.420.02
NT114.10.440.01	NT114.10.440.02	NT114.12.440.01	NT114.12.440.02
Dia 10 mm Right	Dia 10 mm Left	Dia 12 mm Right	Dia 12 mm Left

Available in Length (mm) 320, 340, 360, 380, 400, 420, 440



ML - Tibia Nail

NT106.08.285
NT106.08.300
NT106.08.315
NT106.08.330
NT106.08.345
NT106.08.360
NT106.08.375
| Dia 8 mm

NT106.09.285
NT106.09.300
NT106.09.315
NT106.09.330
NT106.09.345
NT106.09.360
NT106.09.375
| Dia 9 mm

NT106.10.285
NT106.10.300
NT106.10.315
NT106.10.330
NT106.10.345
NT106.10.360
NT106.10.375
NT106.10.390
| Dia 10 mm

Available in Length (mm) 285, 300, 315, 330, 345, 360, 375, 390



Cannulated End Cap
| Length 0 to 15 mm (5 mm increment)
Also available in *ECT289.00 to ECT289.15*



SL - TIBIA NAIL
Interlocking Tibia Nail

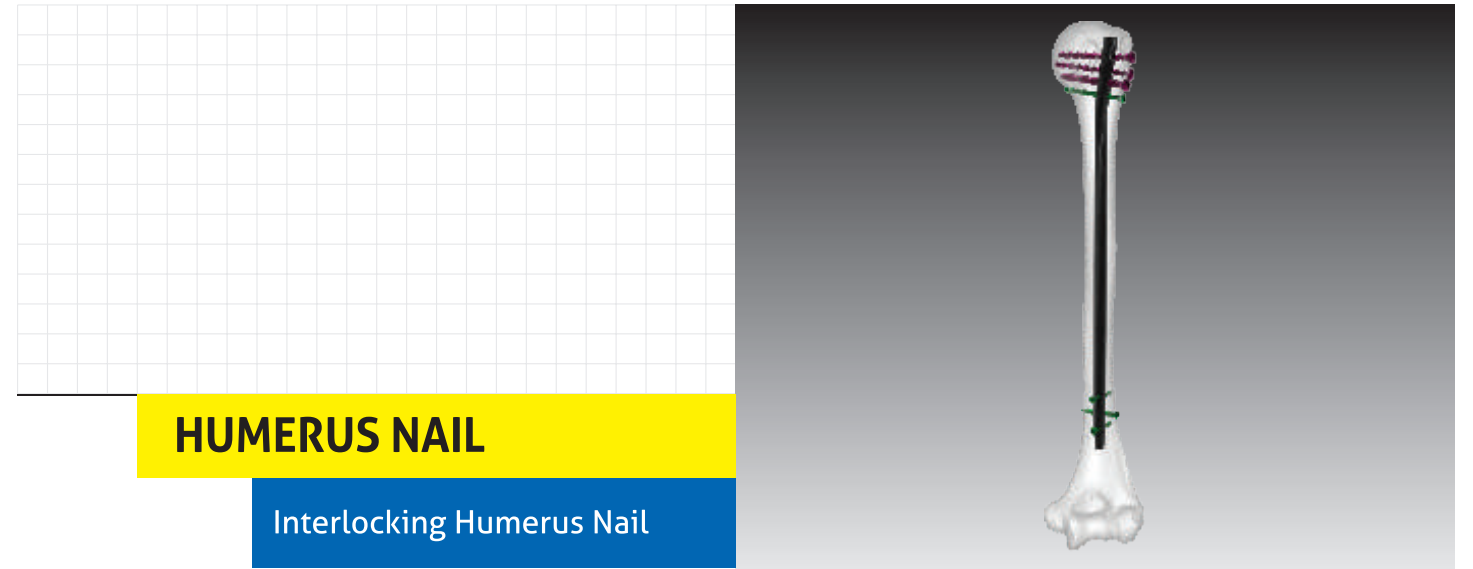

HUMERUS NAIL
Interlocking Humerus Nail



End Cap
| Hight 0, 5, 10, 15 mm (5 mm Increments)
Also available in *ECT111.3.00 to ECT111.3.15*



4.00 mm Locking Bolt
| Length 18 to 80 mm (2 mm Increments)
Also available in *ST108.2.18 to ST108.2.80*



SL - Tibia Nail		
NT099.08.270	NT099.09.270	NT099.10.270
NT099.08.285	NT099.09.285	NT099.10.285
NT099.08.300	NT099.09.300	NT099.10.300
NT099.08.315	NT099.09.315	NT099.10.315
NT099.08.330	NT099.09.330	NT099.10.330
NT099.08.345	NT099.09.345	NT099.10.345
NT099.08.360	NT099.09.360	NT099.10.360
NT099.08.375	NT099.09.375	NT099.10.375
NT099.08.390	NT099.09.390	NT099.10.390
NT099.08.405	NT099.09.405	NT099.10.405
NT099.08.420	NT099.09.420	NT099.10.420
Dia 8 mm	Dia 9 mm	Dia 10 mm

Available in Length (mm) 270, 285, 300, 315, 330, 345, 360, 375, 390, 405, 420



5.00 mm Intramedullary Nail Screw
| Length 26 to 70 mm (2 mm increment)
Also available in *ST117.26 to ST117.70*

| Length 75 to 100 mm (5mm increment)
Also available in *ST117.75 to ST117.100*



Cannulated End Cap
| Length 0 to 15 mm (5 mm increment)
Also available in *ECT289.00 to ECT289.15*



3.5 mm Locking Screw
| Length 18 to 50 (2 mm Increments)
Also available in *ST219.18 to ST219.50*



5.0 mm Locking Screw
| Length 18 to 50 (2 mm Increments)
Also available in *ST220.18 to ST220.50*



Humerus Nail

NT218.65.160	NT218.75.160
NT218.65.180	NT218.75.180
NT218.65.200	NT218.75.200
NT218.65.210	NT218.75.210
NT218.65.220	NT218.75.220
NT218.65.240	NT218.75.240
NT218.65.260	NT218.75.260
NT218.65.280	NT218.75.280
Dia 6.5 mm	Dia 7.5 mm

NT218.70.160	NT218.80.160
NT218.70.180	NT218.80.180
NT218.70.200	NT218.80.200
NT218.70.210	NT218.80.210
NT218.70.220	NT218.80.220
NT218.70.240	NT218.80.240
NT218.70.260	NT218.80.260
NT218.70.280	NT218.80.280
Dia 7.0 mm	Dia 8.0 mm

Available in Length (mm) 160, 180, 200, 210, 220, 240, 260, 280



End Cap
| Hight 0, 5, 10, 15 mm (5 mm Increments)
Also available in *ECT222.00 to ECT222.15*

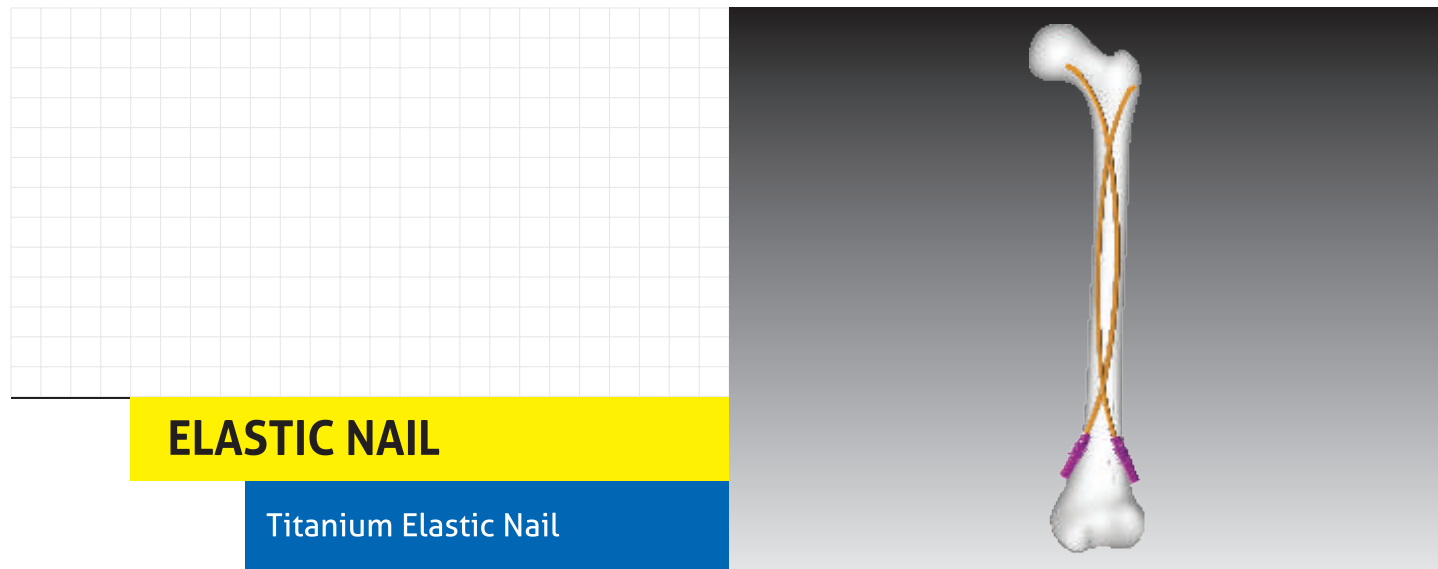

Small End Cap
ECT217.1525
| For Nail Dia 1.5 - 2.5 mm

Large End Cap
ECT217.3040
| For Nail Dia 3.0 - 4.0 mm

Elastic Nail (Titanium)

NT216.15.300 Dia 1.5 mm Available in Length (mm) 300	NT216.30.440 Dia 3.0 mm Available in Length (mm) 440
NT216.20.440 Dia 2.0 mm Available in Length (mm) 440	NT216.35.440 Dia 3.5 mm Available in Length (mm) 440
NT216.25.440 Dia 2.5 mm Available in Length (mm) 440	NT216.40.440 Dia 4.0 mm Available in Length (mm) 440

Pelvic J-Plate

PS116.10.01 Right 10 Holes	PS116.10.02 Left 10 Holes
PS116.12.01 Right 12 Holes	PS116.12.02 Left 12 Holes
PS116.14.01 Right 14 Holes	PS116.14.02 Left 14 Holes
PS116.16.01 Right 16 Holes	PS116.16.02 Left 16 Holes

Pelvic Straight Plate

PS110.03 3 Holes	PS110.09 9 Holes
PS110.04 4 Holes	PS110.10 10 Holes
PS110.05 5 Holes	PS110.11 11 Holes
PS110.06 6 Holes	PS110.12 12 Holes
PS110.07 7 Holes	PS110.13 13 Holes
PS110.08 8 Holes	PS110.14 14 Holes

Pelvic Curve Plate

PS109.06 6 Holes	PS109.10 10 Holes	PS109.14 14 Holes
PS109.08 8 Holes	PS109.12 12 Holes	

Pelvic Symphyseal Plate

PS160.04 4 Hole
PS160.06 6 Hole

Pelvic Spring Plate

PS161.01 1 Hole
PS161.02 2 Hole
PS161.03 3 Hole

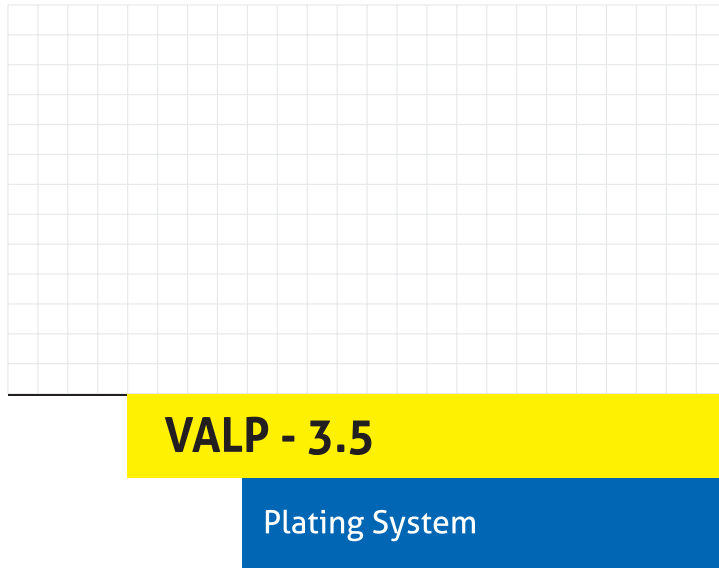

VALP - 3.5

Plating System

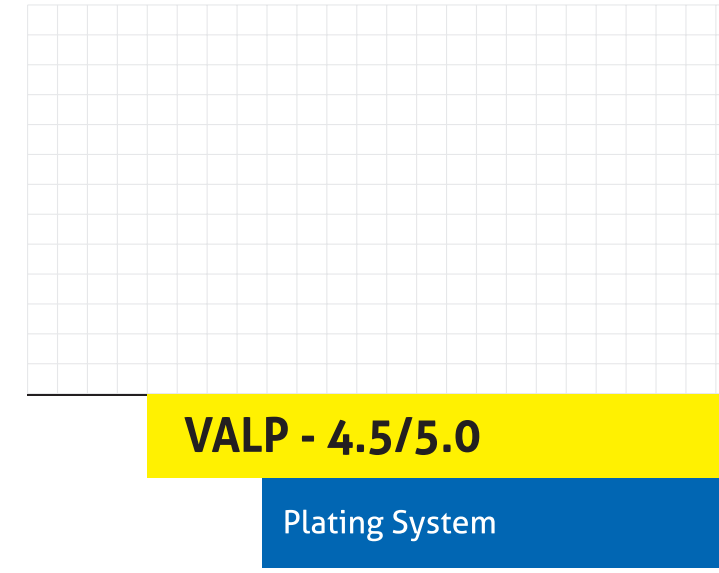

VALP - 4.5/5.0

Plating System



VALP-3.5 Proximal Tibia Plate, Small Bend (LVM)

PS211.04.01 Right 4 Holes	PS211.04.02 Left 4 Holes
PS211.06.01 Right 6 Holes	PS211.06.02 Left 6 Holes
PS211.08.01 Right 8 Holes	PS211.08.02 Left 8 Holes
PS211.10.01 Right 10 Holes	PS211.10.01 Left 12 Holes
PS211.12.01 Right 12 Holes	PS211.12.01 Left 12 Holes
PS211.14.01 Right 14 Holes	PS211.14.01 Left 14 Holes



Variable Angle Locking Screw, ø 3.5mm Self-Tapping (LVM)
| Length 12 to 50 mm (2mm increment)
Also available in SS213.12 to SS213.50

| Length 55 to 100 mm (5 mm increment)
Also available in SS213.55 to SS213.100



ø 3.5 mm Cortex Screw, Self-Tapping (LVM)
| Length 12 to 40 mm (2mm increment)
Also available in SS028.12 to SS028.40

| Length 45 & 50 mm (5 mm increment)
Also available in SS028.45 & SS028.50



VALP-3.5 Proximal Tibia Plate, Large Bend (LVM)

PS212.04.01 Right 4 Holes	PS212.04.02 Left 4 Holes
PS212.06.01 Right 6 Holes	PS212.06.02 Left 6 Holes
PS212.08.01 Right 8 Holes	PS212.08.02 Left 8 Holes
PS212.10.01 Right 10 Holes	PS212.10.02 Left 10 Holes
PS212.12.01 Right 12 Holes	PS212.12.02 Left 12 Holes
PS212.14.01 Right 14 Holes	PS212.14.02 Left 14 Holes



VALP-4.5/5.0 Curved Condylar Plate (LVM)

PS214.05.01 Right 5 Holes	PS214.05.02 Left 5 Holes
PS214.07.01 Right 7 Holes	PS214.07.02 Left 7 Holes
PS214.09.01 Right 9 Holes	PS214.09.02 Left 8 Holes
PS214.11.01 Right 11 Holes	PS214.11.01 Left 11 Holes
PS214.13.01 Right 13 Holes	PS214.13.02 Left 13 Holes
PS214.15.01 Right 15 Holes	PS214.15.01 Left 15 Holes



Variable Angle Locking Screw, ø 5.0mm Self-Tapping (LVM)
| Length 18 to 50 mm (2mm increment)
Also available in SS215.18 to SS215.50

| Length 55 to 95 mm (5 mm increment)
Also available in SS215.55 to SS215.95



ø 4.5 mm Cortex Screw, Self-Tapping
| Length 18 to 70 mm (2mm increment)
Also available in SS029.18 to SS029.70

| Length 55 & 65 mm (5 mm increment)
Also available in SS029.55 to SS029.65

INSTRUMENTS SET

Compact Hand Instruments

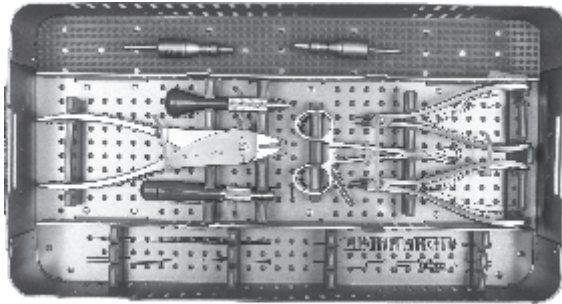

1.5 mm plate

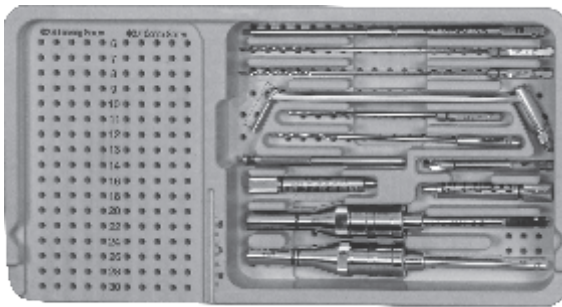

2.0 mm plate

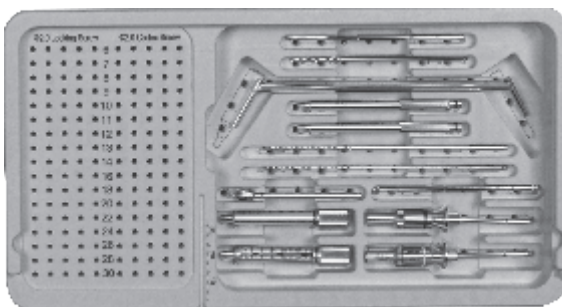

2.4 mm plate

VALP - Distal Radius System

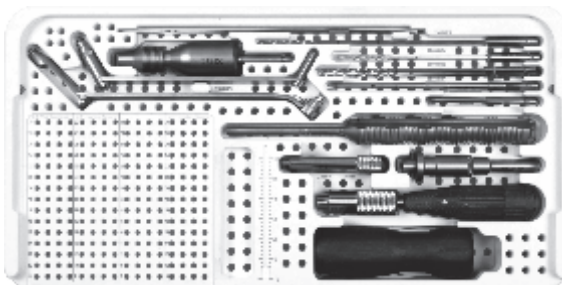

2.4 / 2.7 Distal Radius

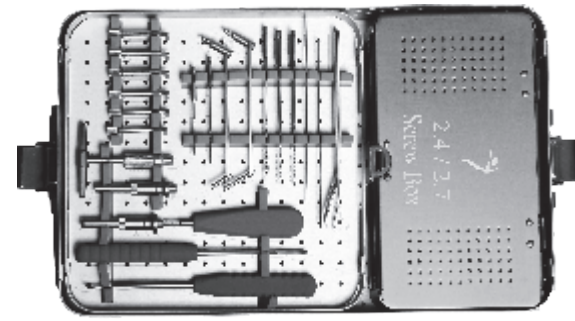
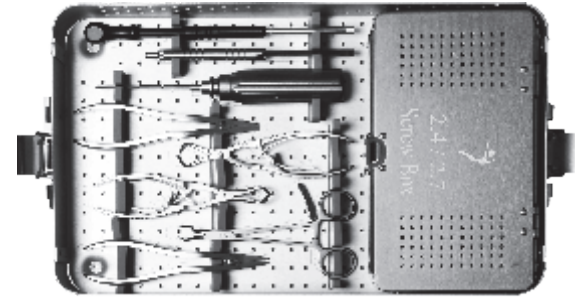

VALP-2.7/3.5 System

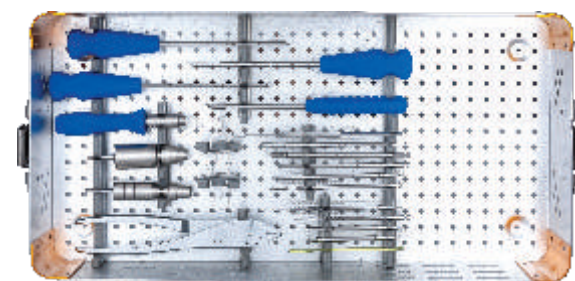
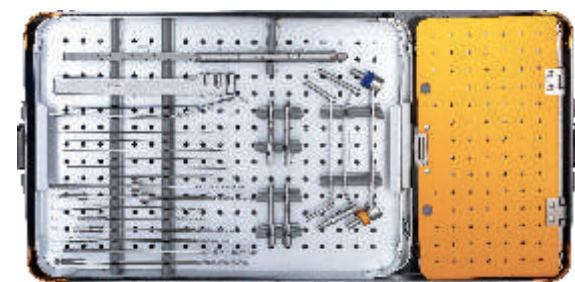
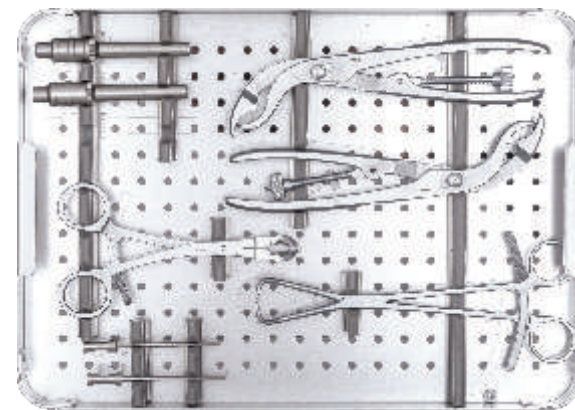

VALP-4.5/5.0 System

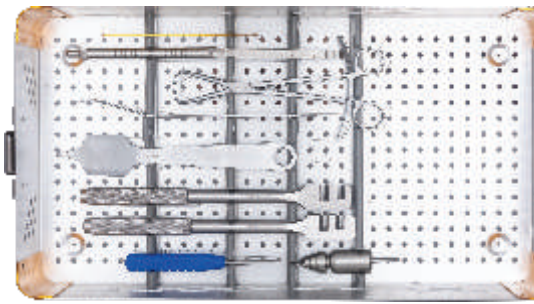
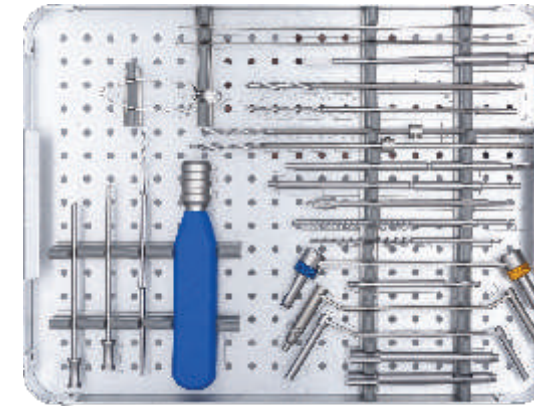
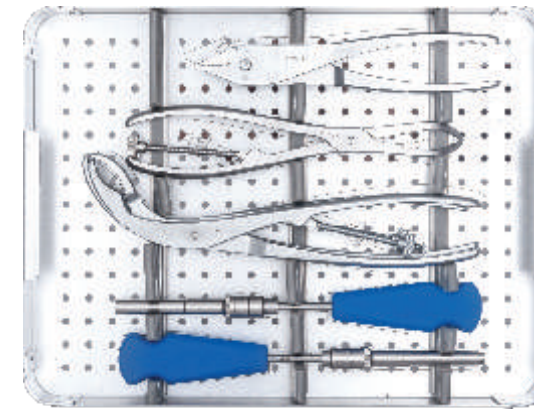

Elbow

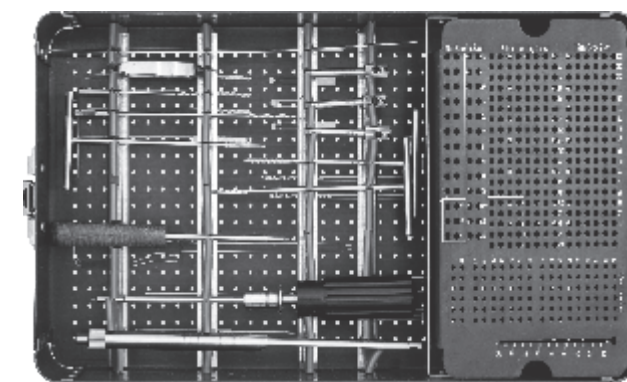
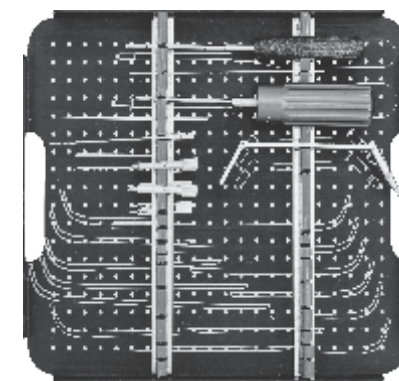

DHS

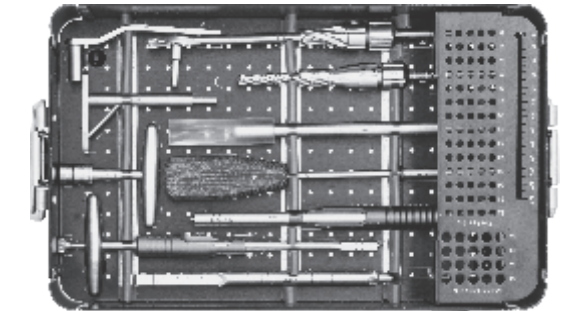
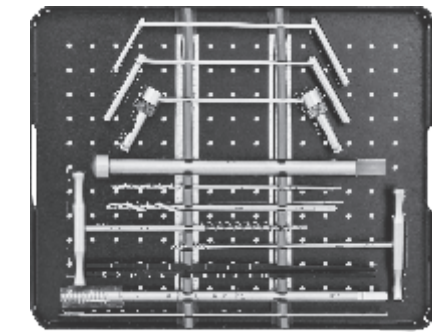

3.5 Locking System

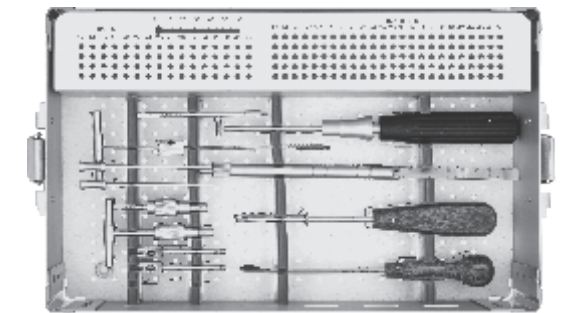

4.5 Locking System

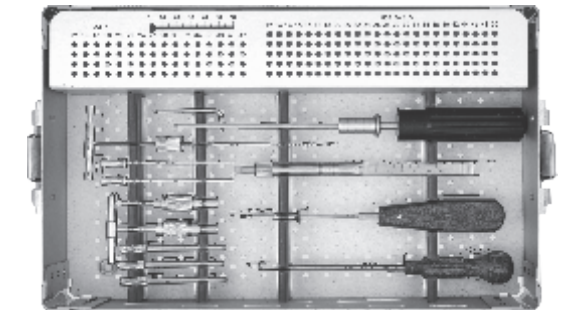
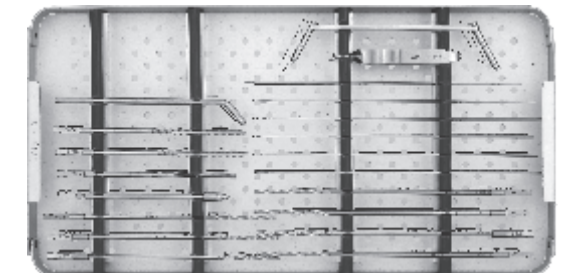

PFAN

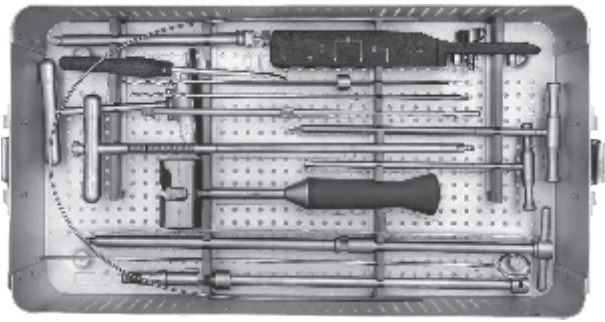
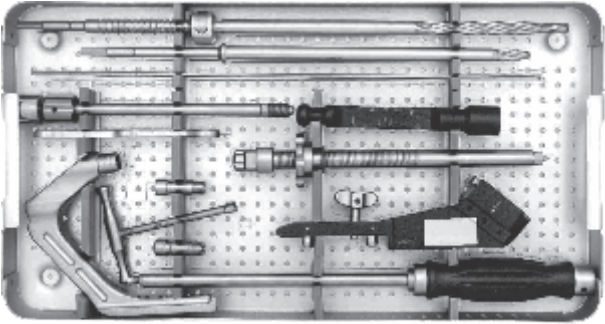
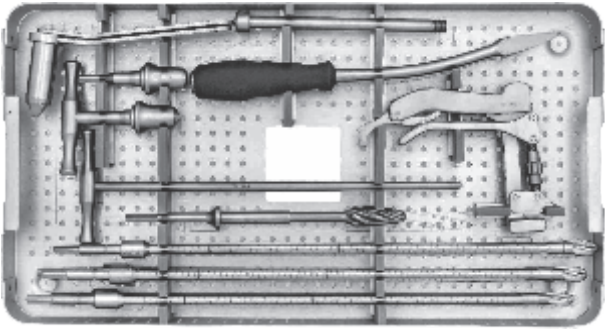

Elastic Nail

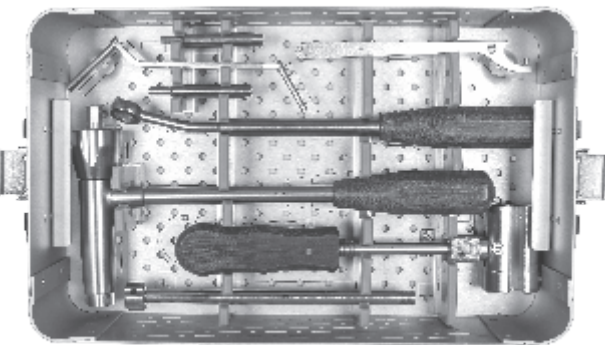
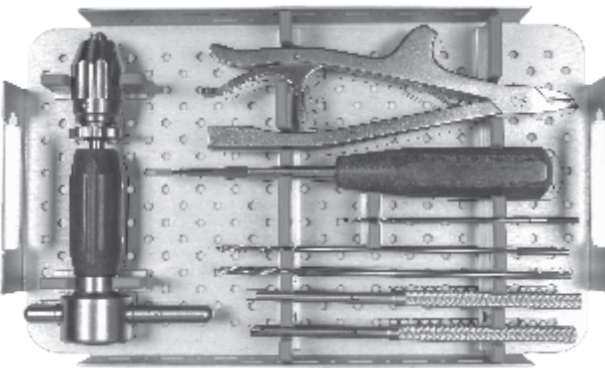

Expert Femur Nail

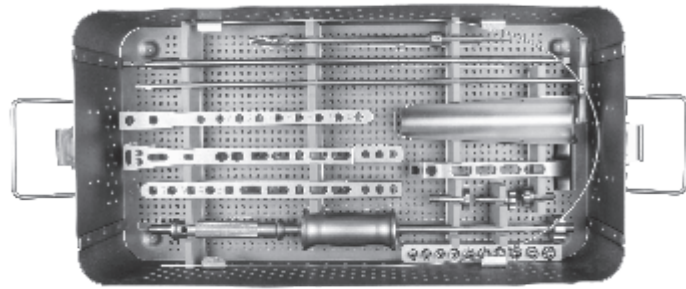
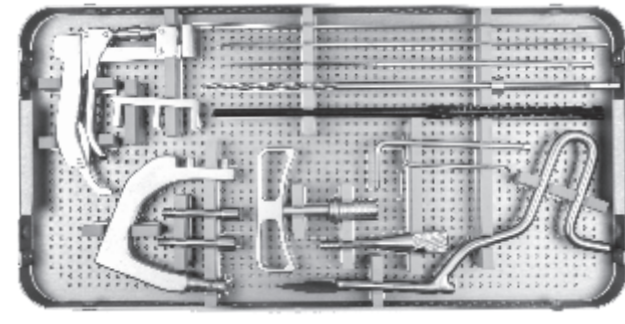
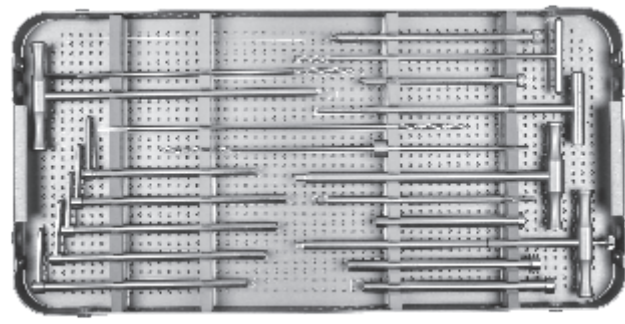

Humerus Nail

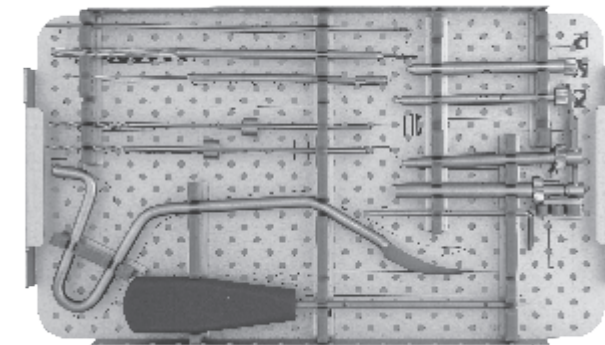
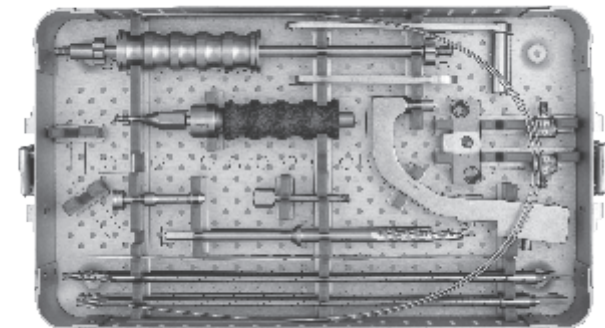

SL / ML - Tibia Nail

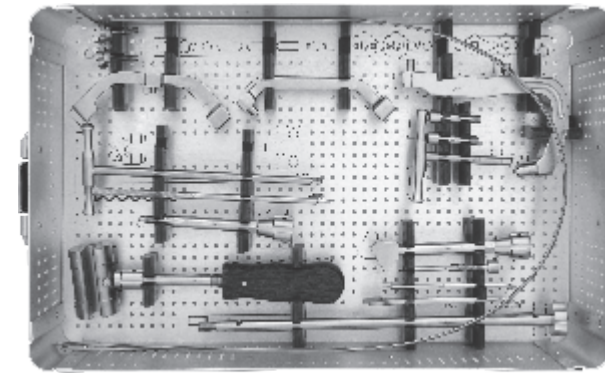
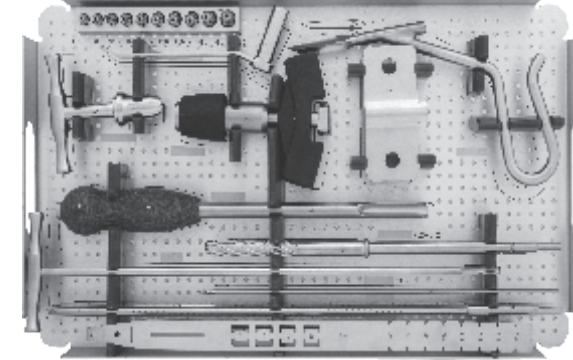
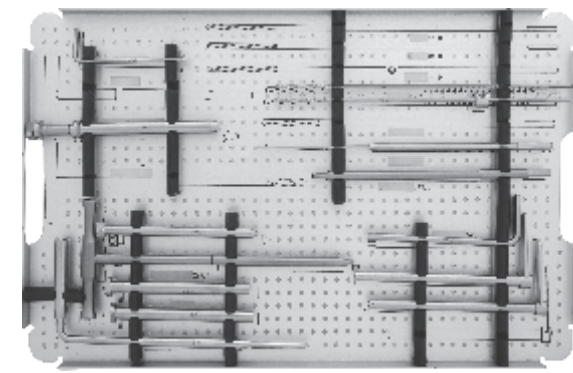

FNS

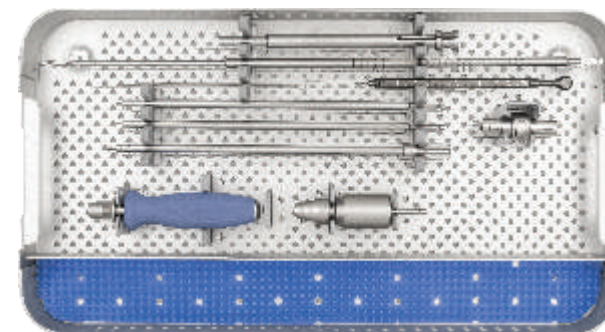
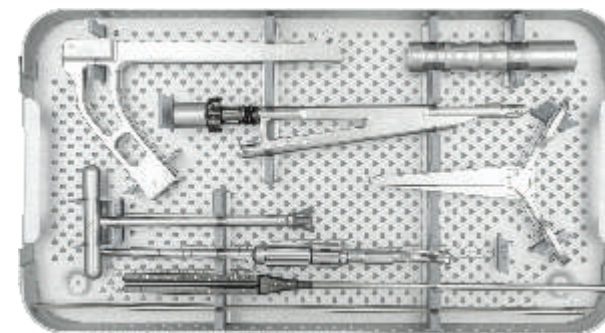

Pelvic

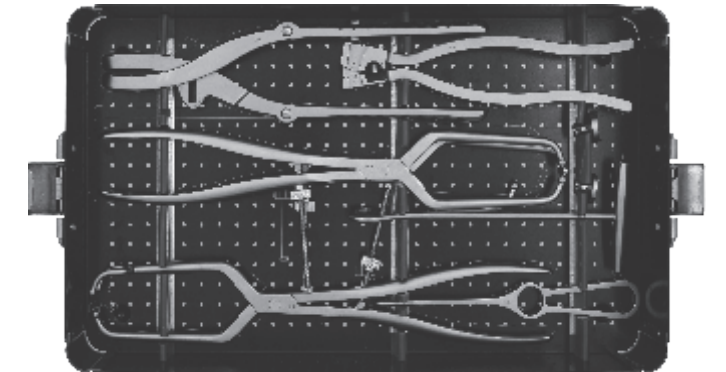
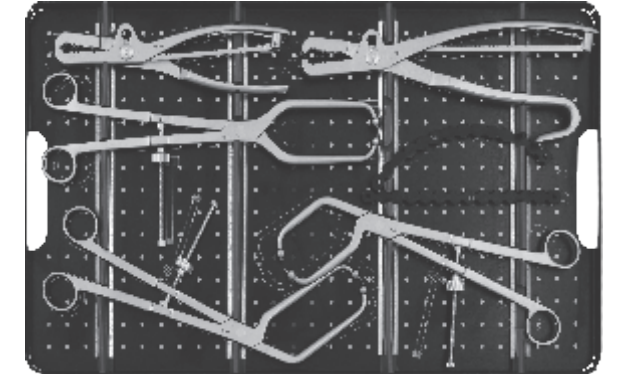
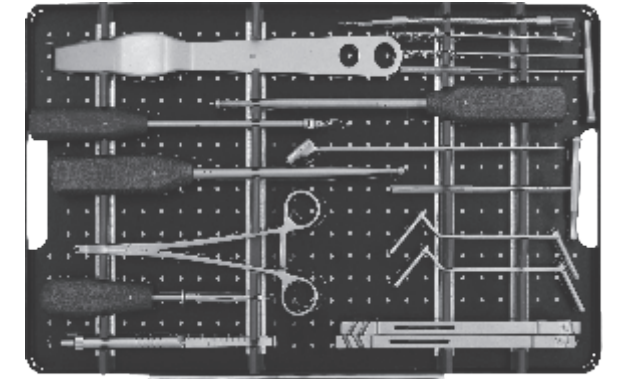

Osteotomy

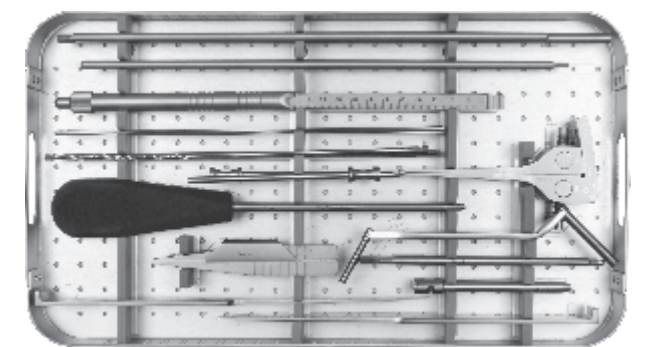
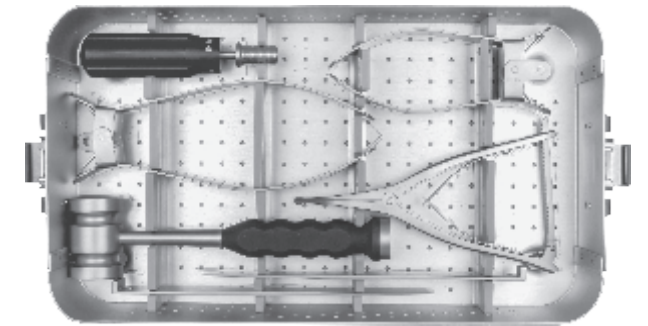



Miraclus Orthotech Pvt. Ltd.

Plant -I :
Plot No. 1112, Phase-3, G.I.D.C., Vatva, Ahmedabad - 382 445.
Phone : +91 79 2583 1332, 2583 1333
Email : contact@miraclus.com | www.miraclus.com

Plant -II :
Survey No. 106, Village Vavdi, Opp. Safex Industries,
Behind Elite Boarding School, Vavdi,
Ta. Kheda-387550, Gujarat, India